

RELAYS

Energy Series | Railway Series

AMRA Line | MTI Line



UPDATE

Ed. 10/2022

- RCG/RDG** RELAYS WITH 2-4 FORCIBLY GUIDED CONTACTS EN61810-3
- RMGX** RELAY WITH 8 FORCIBLY GUIDED CONTACTS EN61810-3
- RMGW** RELAY WITH 8 FORCIBLY GUIDED CONTACTS
- RGK** MULTISCALE RELAY WITH 4 FORCIBLY GUIDED CONTACTS
- RMMX** MONOSTABLE RELAY WITH 8 CONTACTS
- RMBX** BISTABLE (LATCHING) RELAY WITH 7-8 CONTACTS
- TMM** MULTIFUNCTION MULTISCALE RELAY WITH 4 CONTACTS
- PRIR** SOCKET WITH REAR CONNECTION SPRING CLAMP



ENG

*RELAY*bility

RCG RDG

FORCIBLY GUIDED CONTACTS

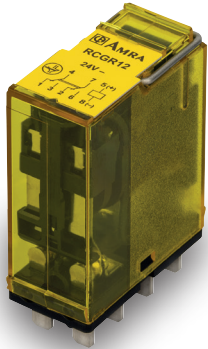

RCG

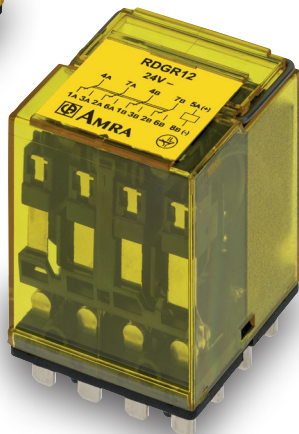

RDG

INSTANTANEOUS RELAYS, WELD-NO-TRANSFER 2-4 CONTACTS

APPLICATIONS



OVERVIEW

- Forcibly guided (mechanically linked) contacts, relays compliant with **EN 61810-3, type A**
- Weld-no-transfer technology
- High performance, compact dimensions, light weight
- Compact plug-in monostable instantaneous relays
- Suitable for safety applications
- Solid and rugged construction for intensive duty, IP50 protection
- Self-cleaning knurled contacts, C/O type
- High electrical life expectancy
- Wide temperature range -40°C ... +85°C
- New "HIGH POWER" magnetic arc blow-out for improved breaking capacity (as option)
- Wide option range: signalling LED, FLYBACK DIODE, varistor, etc.
- Retaining clip for secure locking of relay on socket
- Transparent cover, pull-out handle

DESCRIPTION

RCG & RDG relay, with 2 & 4 changeover contacts, are highly reliable products featuring high performance, suitable for applications in very harsh and disturbed environments, such as **ROLLING STOCK** applications.

Referring to the standard **EN61810-3**, these relays are classified as fully compliant and identified as **type A** relays, (all the contacts are mechanically linked). Forcibly guided contacts are also known as weld-no-transfer contacts.

The construction of the relays and careful choice of the materials ensure long life and considerable ruggedness even in harsh operating environments and in the presence of strong temperature fluctuations.

Wide range of coil's nominal voltage are available. The manufacturing versatility allows to adapt power supply to customer needs.

The IP50 protection allows the relays to be used even in dusty environments, protecting contact's surface against harmful deposits, with great benefit in conducting very low loads.

The operating temperature range is -40°C to +85°C. RCG and RDG can operate in environment with high thermal shocks.

The contacts are designed to obtain remarkable performances both for high, inductive loads or very low loads. Each contact is able to switch from 5mA – 10V even without contact gilding.

The knurled surface ensures an excellent self-cleaning effect, a lower ohmic resistance thanks to the various points of electrical contact, and will also improve the electrical life of the component.

The magnetic arc blow-out contributes to increase breaking capacity: the relay is suitable for controlling heavy duty loads with intensive switching frequency.

In this relay range, with forcibly guided contacts (mechanically linked) special design and constructional measures are used to ensure that make (NO) contacts cannot assume the same state as break (NC) contacts.

- If, when powering up a relay, a NC contact fails to open, the remaining NO contacts must not close, maintaining a contact gap ≥ 0.5 mm

- When the relay is de-energized, if a NO contact fails to open, the remaining NC contact must not close, maintaining a contact gap ≥ 0.5 mm

In the case of relays that include changeover contacts, either the make circuit or the break circuit of a changeover contact can be considered to meet the requirements of this standard.

STANDARD COMPLIANCE

EN 61810-3	EN 61810-1
EN 60077	EN 61810-7
EN 50155	EN 60695-2-10
EN 61373	EN 61000
EN 45545-2	EN 60529
ASTM E162, E662	

MODELS	NUMBER OF CONTACTS	MAGNETIC ARC BLOW-OUT	HIGH POWER - MAGNETIC ARC BLOW-OUT
RCG.x2	2		
RCG.x6	2	•	
RCG.x8	2		•
RDG.x2	4		
RDG.x6	4	•	
RDG.x8	4		•

FOR PRODUCT CODE CONFIGURATION, SEE THE "ORDERING SCHEME" TABLE

COIL DATA	RCG	RDG
Nominal voltages Un	DC: 24-36-48-72-96-110-125 ⁽¹⁾	
Consumption at Un	2.2 W	2.7 W
Operating range	80 ÷ 115 % Un	
Operating range for rolling stock version ⁽²⁾	70 ÷ 125 % Un	
Type of duty	Continuous	
Drop-out voltage ⁽³⁾	DC: > 5% Un	

(1) Other values on request.

(2) See "Ordering scheme" table for order code. Suitable for application on ROLLING STOCK. Operating range in accordance with EN60077.

(3) Limit value for supply voltage, expressed as % of the nominal value, beneath which the relay is certainly de-energized.

CONTACT DATA	RCG	RDG		
	2 SPDT, form C	4 SPDT, form C		
Number and type				
Current	See the following chart			
Nominal	13A for 1min - 20A for 1s			
Maximum peak ⁽¹⁾	100A for 10ms			
Maximum pulse ⁽¹⁾				
Example of electrical life ⁽²⁾	Standard: RCG.x2 / RDG.x2: 0,2A - 110Vdc - L/R 40ms - 5x10 ⁵ oper. *			
* 1,200 oper./h	With Magnetic arc blowout: RCG.x6 / RDG.x6: 0.5A - 110Vdc - L/R 40ms - 1.5x10 ⁵ oper. *			
** 600 oper./h	With HIGH POWER Magn. arc blowout: RCG.x8 / RDG.x8: 0.7A - 132Vdc - L/R 40ms - 7x10 ⁴ oper. **			
Minimum load ⁽³⁾	200mW (10V, 10mA)			
Standard contacts	50mW (5V, 5mA)			
Gold-plated contact ⁽⁴⁾				
Making capacity	30 A - 110Vdc - L/R 0 ms : 2,000 operations			
Maximum breaking voltage	250 Vdc / 300 Vac			
Contact material	AgSnO ₂ (mobile contacts) - AgNi (fixed contacts)			
Operating time at Un (ms) ⁽⁵⁾	Standard	With diode	Standard	With diode
Pick-up (NC contact opening)	≤ 13	≤ 13	≤ 17	≤ 17
Pick-up (NO contact closing)	≤ 19	≤ 19	≤ 25	≤ 25
Drop-out (NO contact opening)	≤ 4	≤ 11	≤ 4	≤ 27
Drop-out (NC contact closing)	≤ 16	≤ 30	≤ 14	≤ 43

(1) The max. peak and pulse currents are those currents that can be handled, for a specified time, by the contact. They do not refer to steady or interrupted currents.

(2) For other examples, see electrical life expectancy table.

(3) Values referred to a new product, measured in laboratory. The ability to maintain this performance over the time depends on the environmental conditions and the contact' frequency use. The use of gold plated contacts is recommended in the case of very low loads.

(4) A gold contact, if subjected to high loads, degrades superficially. In this case, the characteristics of the standard contact must be considered. This does not affect the operation of the relay.

(5) Unless specified otherwise, the operating times refer to the stabilization of the contact (including bounces).

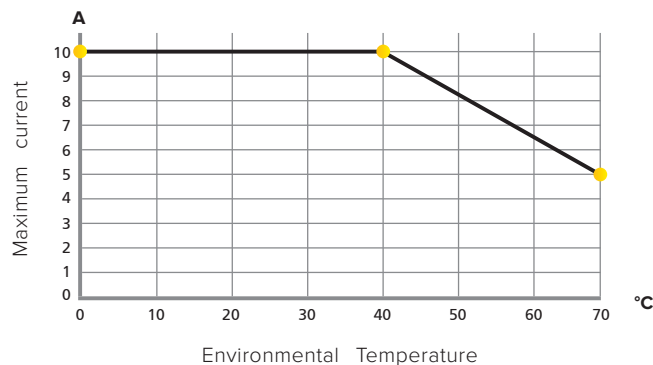

INSULATION

Insulation resistance (at 500Vdc) between electrically independent circuits and between these circuits and ground between open contact parts	> 1,000 MΩ > 1,000 MΩ
Dielectric withstanding voltage at industrial frequency between electrically independent circuits and ground between coil and contacts parts between adjacent contacts between open contact parts	4 kV (1 min) 3 kV (1 min) 3.5 kV (1 min) 2 kV (1 min)
Impulse withstand (1.2/50µs - 0.5J) between electrically independent circuits and ground between open contact parts	5 kV 3 kV

MECHANICAL SPECIFICATIONS

Mechanical life expectancy	20x10 ⁶ operations	
Maximum switching rate	Mechanical	3,600 operations / h
Protection rating (with relay mounted)	IP50	
	RCG	RDG
Dimensions (mm)	40x20x50 ⁽¹⁾	40x40x50 ⁽¹⁾
Weight (g)	60	115

(1) Output terminals excluded.

ENVIRONMENTAL CHARACTERISTICS

Operating temperature	Standard	-25 ÷ +55°C	
	Version for railways, rolling stock	-25 ÷ +70°C (+85°C for 10min)	-40°C as option
Storage and shipping temperature		-40 ÷ +85°C	
Relative humidity		Standard: 75% RH - Tropicalized: 95% RH	
Fire behaviour		V0	

STANDARDS AND REFERENCE VALUES

EN 61810-1, EN 61810-7	Electromechanical elementary relays
EN 61810-3, type A	Relays with forcibly guided (mechanically linked) contacts, type A
EN 60695-2-10	Fire behaviour
EN 61000	Electromagnetic compatibility
EN 60529	Degree of protection provided by enclosures

Unless otherwise specified, the products are designed and manufactured according to the requirements of the above-mentioned European and International standards.

In accordance with EN 61810-1, all technical data are referred to ambient temperature of 23°C, atmospheric pressure of 96kPa and 50% humidity.
Tolerance for coil resistance and nominal power is ±5%.**RAILWAYS, ROLLING STOCK - STANDARDS APPLICABLE TO RCGR & RDGR VERSIONS**

EN 60077	Electric equipment for rolling stock - General service conditions and general rules
EN 50155	Electronic equipment used on rolling stock - T3 class
EN 61373 ⁽¹⁾	Shock and vibration tests, Cat 1, Class B
EN 45545-2	Fire behaviour, HL3 : Cat E10 (Requirement R26)
ASTM E162, E662	Fire behaviour

(1) only for RDGR family: permissible opening time of contacts on a de-energized relay t<100µs

CONFIGURATIONS - OPTIONS

TROPICALIZATION	Surface treatment of the coil with protective coating for use with RH 95%.
GOLD PLATING	Surface treatment of the contacts, blades and output terminals with gold-cobalt alloy ≥ 2µ. This treatment ensures long-term capacity of the contact to conduct lower currents.
LED	LED indicator showing presence of power supply. Flyback diode mounted as standard.
FLYBACK DIODE	Component connected in parallel to the coil (type BYW56) designed to dampen overvoltages generated by the coil when de-energized.
TRANSIL	Non-polarized component connected in parallel to the coil. Behaviour is similar to that of a varistor with faster operating times.
LOW TEMPERATURE	Minimum operating temperature -40°C, only for rolling stock version (option "L").



ORDERING SCHEME

PRODUCT CODE	APPLICATION ⁽¹⁾	CONFIGURATION A	CONFIGURATION B	TYPE OF POWER SUPPLY	N	FINISH ⁽³⁾	KEYING POSITION CODE ⁽⁴⁾
RCG (2 contacts)	E: Energy	1: Standard 2: Gold plating + Diode // + Led	2: Standard	C: Vdc	024 - 036 048 - 072 096 - 110 - 125	T: Tropicalized coil	XX
RDG (4 contacts)	F: Railway Fixed Equipment R: Railway Rolling stock	3: Diode // 4: Gold plating 6: Gold plating + Diode // 7: Diode // + Led 8: Transil	6: With magnetic arc blow-out 8: With HIGH POWER magnetic arc blow-out				

Example

RCG	E	4	2	C	048		
RCGE42-C048 = ENERGY series relay with 2 SPDT gold-plated contacts, 48Vdc coil							
RDG	R	1	6	C	110		
RDGR16-C110 = RAILWAY series relay, rolling stock, with 4 SPDT contacts, magnetic arc blow-out, 110Vdc coil							

1. **ENERGY:** all applications except for railway.

RAILWAYS, FIXED EQUIPMENT: application on fixed power systems and electrical railway traction. Construction according to RFI (FS Group, Italy) specification n° RFI DPRIM STF IFS TE 143 A, if applicable for list of RFI approved and conforming products, consult dedicated catalogue "RAILWAY SERIES - RFI APPROVED"

RAILWAYS, ROLLING STOCK: Application on board rolling stock. Electrical characteristics according to EN60077.

2. Other values on request.

3. Optional value.

4. Optional value. The positive mechanical keying is applied according to the manufacturer's model.



WIRING DIAGRAM

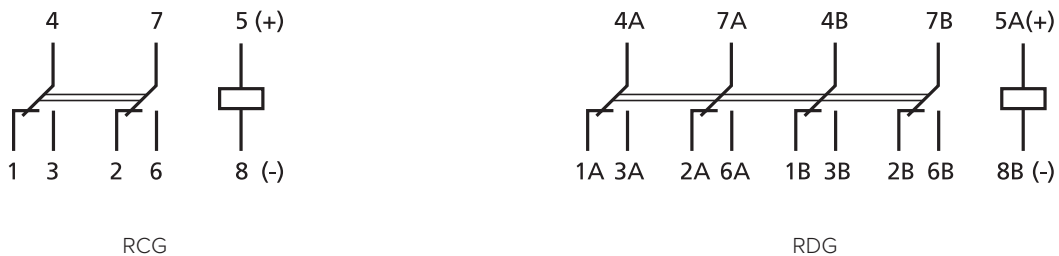

DIMENSIONS

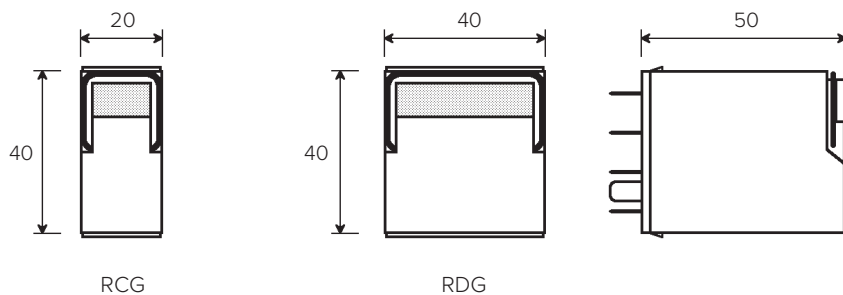



Some examples of electrical life expectancy

RCG.12, RDG.12			
U	I (A)	L/R (ms)	Oper.
110Vdc	0.2	40	500,000
220Vdc	0.2	10	80,000
U	I (A)	cosφ	Oper.
110Vac	1	1	1,200,000
110Vac	1	0.5	1,000,000
110Vac	5	1	500,000
110Vac	5	0.5	300,000
220Vac	0.5	1	1,200,000
220Vac	1	0.5	500,000
220Vac	5	1	400,000
220Vac	5	0.5	300,000

RCG.16, RDG.16			
U	I (A)	L/R (ms)	Oper.
110Vdc	0.2	40	1,000,000
110Vdc	0.5	40	150,000
110Vdc	0.6	10	300,000
110Vdc	1	10	100,000
220Vdc	0.2	10	100,000
U	I (A)	cosφ	Oper.
110Vac	1	1	2,000,000
110Vac	1	0.5	1,500,000
110Vac	5	1	950,000
110Vac	5	0.5	500,000
220Vac	0.5	1	2,000,000
220Vac	1	0.5	800,000
220Vac	5	1	600,000
220Vac	5	0.5	500,000

RCG.18, RDG.18			
U	I (A)	L/R (ms)	Oper.
24Vdc	1	0	5,100,000
24Vdc	2	0	3,900,000
24Vdc	3	0	2,900,000
24Vdc	4	0	2,600,000
24Vdc	5	0	2,200,000
24Vdc	1	20	2,700,000
24Vdc	2	20	2,100,000
24Vdc	3	20	1,500,000
24Vdc	3.5	20	1,000,000
24Vdc	1	40	2,000,000
24Vdc	2	40	1,500,000
24Vdc	3	40	1,100,000
24Vdc	3.5	40	800,000
110Vdc	0.3	0	1,000,000
110Vdc	0.5	0	700,000
110Vdc	1	0	190,000
110Vdc	0.3	20	450,000
110Vdc	0.5	20	260,000
110Vdc	0.8	20	600,000 ⁽¹⁾
110Vdc	1	20	100,000
110Vdc	0.3	40	300,000
110Vdc	0.5	40	180,000
110Vdc	0.6	40	150,000
110Vdc	0.7	40	100,000
132Vdc	0.7	40	70,000

Switching frequency: 1,200 operations/hour

⁽¹⁾ 2 series contacts

SOCKETS AND RETAINING CLIPS

Type of installation	Type of outputs	RCG	RDG	RETAINING CLIP
		Model		
Wall or DIN H35 rail mounting	Spring clamp	PAIR080	PAIR160	VM1831
	Screw	50IP20-I DIN	48BIP20-I DIN	VM1831
Flush mounting	Spring clamp	PRIR080	PRIR160	VM1831
	Double faston (4.8 x 0.8 mm)	ADF1	ADF2-BIPOK	VM1831
PCB-mount	Solder	65 ⁽¹⁾	65	VM1841

⁽¹⁾ Suitable for mounting 2 relays side by side.

INSTALLATION, OPERATION AND MAINTENANCE



Installation

Before installing the relay on a wired socket, disconnect the power supply.

The preferential mounting position is on the wall, with the relay positioned horizontally in the "reading orienting" of marking so that the label is readable in the correct sense.

Spacing: the distance between adjacent relays depends on use' conditions.

If a relay is used in the "less favorable" conditions that occur with "simultaneously":

- Power supply: the maximum allowed, permanently
- Ambient temperature: the maximum allowed, permanently
- Current on the contacts: the maximum allowed, permanently
- Number of contacts used: 100%

it is strongly recommended to space relay at least 5 mm horizontally and 20 mm vertically, to allow for proper upward heat' dissipation and increase the longevity of the component.

Actually, relays could be used in less severe conditions. In this case, the distance between adjacent relays can be reduced or abolished. A correct interpretation of the use' conditions allows the optimization of the available spaces. Contact AMRA for more information.

To increase relay' longevity, we recommend mounting relays intended for "continuous use" (permanent power supply), alternating them with relays intended for less frequent use.

For a safe use, the retaining clip is recommended. For use on rolling stock, relays have been tested to EN 61373 standard equipped with retaining clip(s).

Operation

Before use: if relay is not used, for example after long storage periods, contact resistance may increase due to a natural and slight oxidation or polluting deposits.

In order to restore the optimal conductivity and for standard contacts (NOT gold plated) it is recommended to switch several time a load of at least 110Vdc - 100mA or 24Vdc - 500mA. The contacts will be "cleaned" thanks to the electric arc generated during the current interruption and the mechanical self-cleaning action.

The common contact rubs against the fixed poles (NO and NC contacts) both when opening and when closing, which ensures a self-cleaning action.

An increase in contacts' resistance, in most cases, does not represent a problem. Many factors contribute to the correct use of contact and consequently to the relay' long-term reliability:

- **Load:** the current switching generates an electric arc with cleaning effects. For proper electrical cleaning and performance keeping we recommend:
 - o Standard contacts: Minimum current = 20mA
 - o Gold plated contacts: Minimum current = 10mA
- **Operating frequency:** relays are components that can operate with a wide range of switching frequency. High frequency operation also allows a continuous cleaning effect by "sliding" (mechanical cleaning). In case of low frequency operation (for example few time a day), we advise:
 - o Use of contact with currents twice compared to those indicated.
 - o For currents lower than 10mA, use gold plated contacts and connect 2 contacts in parallel, in order to reduce the equivalent contact resistance
- **Pollution:** the presence of pollution can cause impurities on contact surface. Electric charges attract organic molecules and impurities that are deposited on the contact surface. Electrical and mechanical cleaning, respectively, burn and remove such impurities. In pollution presence, the minimum recommended currents must be respected. In extreme cases, provide double the cleaning current.

Condensation is possible inside the relay when energized and the outside ambient temperature is cold; this is quite normal and does not affect the operation of the relay. Plastic materials of relay do not possess hygroscopic properties.

Maintenance

No maintenance is required.

In case of normal relay wear (reaching the end of electrical or mechanical life), the relay cannot be restored and must be replaced.

To check the component, relay removal must be carried out with slight lateral movements. An "up and down" movement can cause terminals damage.

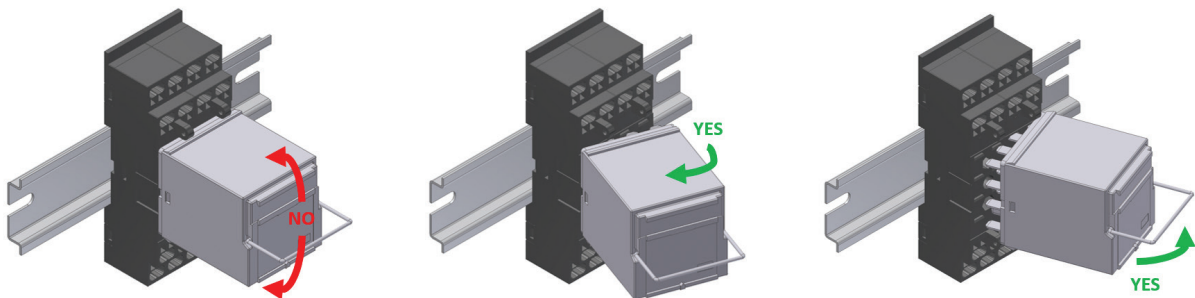

Often the malfunctions are caused by power supply with inverted polarity, by external events or by use with loads exceeding the contact performance.

In case of suspected malfunction, energize relay and observe if mechanical operation of contacts / relay mechanism is performed. Pay attention to the power supply polarity, if relay is equipped with polarized components (example: diode, led).

- In case of expected operation, clean the contacts (see paragraph "OPERATION") and check if the circuit load ranges within the contact performance. If necessary, replace with relays with gold contacts. Note: the electrical continuity of contacts must be checked with adequate current.
- If it does not work, we recommend to use a relay of the same model and configuration.

If an investigation by AMRA is required, pull-out the relay from the socket, don't remove the cap, avoid any other manipulation and contact us. You will be asked for the following data: environmental conditions, power supply, switching frequency, contact load, number of operations performed.

The fault can be described through the "TECHNICAL SUPPORT" section of the website www.amra-chauvin-arnoux.it.

In any case, the relay cannot be repaired by the user.

Storage

Storage conditions must guarantee the environmental conditions (temperature, humidity and pollution) required for the product conservation, in order to avoid deterioration.

The product must be stored in an environment sheltered from atmospheric agents and not polluted, with an ambient temperature between -40 and +85°C with max 75% RH. Humidity can reach peaks of 95%. In any case, there must be no condensation. Before use, please read carefully "OPERATION" section.

RMGX

INSTANTANEOUS RELAYS, WELD-NO-TRANSFER 8 CONTACTS

FORCIBLY GUIDED CONTACTS

APPLICATIONS



OVERVIEW

- Forcibly guided (mechanically linked) contacts, relays compliant with **EN 61810-3, type A**
- Weld-no-transfer technology
- Plug-in monostable instantaneous relays
- Suitable for safety applications
- Solid and rugged construction for intensive duty
- Self-cleaning knurled contacts
- Very high electrical life expectancy and exceptional endurance
- Magnetic arc blow-out for higher breaking capacity
- Wide option range: signalling LED, FLYBACK DIODE, varistor, etc.
- Cover with matte finishing with access for manual operation (standard) and pull-out handle

DESCRIPTION

RMGX relays are highly reliable products featuring high performance, suitable for applications in very harsh and disturbed environments, such as **ROLLING STOCK** applications.

Referring to the standard **EN61810-3**, these relays are classified as fully compliant and identified as **type A** relays, (all the contacts are mechanically linked). Forcibly guided contacts are also known as weld-no-transfer contacts.

Equipped by C/O contacts: the user have the greatest possible flexibility in designing (6 NC + 2 NO, 5 NC + 3 NO, etc.).

Wide contact gap for a very high breaking capacity, electrical life expectancy and insulation.

The operating temperature range is -40°C to +85°C. RMG can operate in environment with high thermal shocks.

Manual operation as standard for all models, allowing tests to be conducted in the absence of any power supply.

The contacts are designed to obtain remarkable performances both for high, inductive loads or very low loads. Each contact is able to switch from 5mA – 10V even without contact gilding.

The knurled surface ensures an excellent self-cleaning effect, a lower ohmic resistance thanks to the various points of electrical contact, and will also improve the electrical life of the component.

The magnetic arc blow-out contributes to increase breaking capacity: the relay is suitable for controlling heavy duty loads with intensive switching frequency.

In this relay range with forcibly guided contacts (mechanically linked) special design and constructional measures are used to ensure that make (NO) contacts cannot assume the same state as break (NC) contacts.

- If, when powering up a relay, a NC contact fails to open, the remaining NO contacts must not close, maintaining a contact gap ≥ 0.5 mm

- When the relay is de-energized, if a NO contact fails to open, the remaining NC contact must not close, maintaining a contact gap ≥ 0.5 mm

In the case of relays that include changeover contacts, either the make circuit or the break circuit of a changeover contact can be considered to meet the requirements of this standard.

STANDARD COMPLIANCE

EN 61810-3	ASTM E162, E662
EN 60077	EN 61810-1
EN 50155	EN 61810-7
EN 61373	EN 60695-2-10
EN 45545-2	EN 60529

MODELS	NUMBER OF CONTACTS	MAGNETIC ARC BLOW-OUT
RMG.x2X	6 SPDT + 2 NO	
RMG.x6X	6 SPDT + 2 NO	•

FOR PRODUCT CODE CONFIGURATION, SEE THE "ORDERING SCHEME" TABLE

COIL DATA	RMGExyX - RMGFxyX	RMGRxyX
Nominal voltages Un	DC : 24-48-110-125-132-220 ⁽¹⁾	DC : 24-36-72-96-110 ⁽²⁾
Consumption at Un (DC/AC)	3W	
Operating range	DC : 80÷115% Un	DC : 70÷125% Un
Type of duty	Continuous	
Drop-out voltage ⁽³⁾	DC : > 5% Un	

(1) Other values on request.

(2) Suitable for application on rolling stock. Operating range in compliance with EN 60077 standard.

(3) Limit value for supply voltage, expressed as % of the nominal value, beneath which the relay is certain to be de-energized.

CONTACT DATA	RMG.12X-16X-42X-46X	RMG.32X-36X-52X-56X-62X-66X
Number and type	6 SPDT+ 2 NO, form C	
Current	See following graph	
Nominal	20A for 1min - 40A for 1s	
Maximum peak ⁽¹⁾	150A for 10ms	
Maximum pulse ⁽¹⁾		
Example of electrical life expectancy	RMG.x2X : 0.5A - 110Vdc - L/R 40ms - 10 ⁵ operations - 1,800 operations / hour RMG.x6X : 1A - 110Vdc - L/R 40ms - 10 ⁵ operations - 1,800 operations / hour	
Minimum load ⁽²⁾	Standard contacts	200mW (10V, 10mA)
	Gold-plated contacts ⁽³⁾	50mW (5V, 5mA)
Maximum breaking voltage	350 VDC / 440 VAC	
Contact material	AgCdO	
Operating time at Un (ms) ⁽⁴⁾	DC	
Pick-up (NC contact opening)	≤ 35	
Pick-up (NO contact closing)	≤ 60	
Drop-out (NO contact opening)	≤ 4	
Drop-out (NC contact closing):	≤ 45	

(1) Maximum peak and pulse currents are those currents that can be handled, for a specified time, by the contact. They do not refer to steady or interrupted currents.

(2) Values referred to a new product, measured in laboratory. The ability to maintain this performance over the time depends on the environmental conditions and the contact' frequency use. The use of gold plated contacts is recommended in the case of very low loads.

(3) A gold contact, if subjected to high loads, degrades superficially. In this case, the characteristics of the standard contact must be considered. This does not affect the operation of the relay.

(4) Unless specified otherwise, the operating time signifies until stabilization of the contact (including bounces).

RATED CURRENT CONTACTS

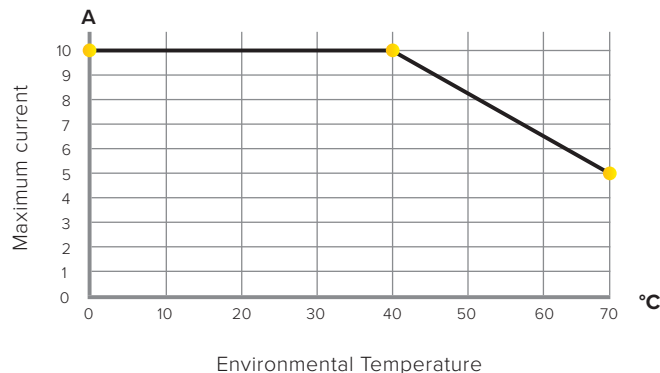

Note: reduction of 30% on all the contacts simultaneously.

INSULATION

Insulation resistance (at 500VCD) between electrically independent circuits and between these circuits and ground	> 10,000 MΩ
between open contact parts	> 10,000 MΩ
Withstand voltage at industrial frequency between electrically independent circuits and between these circuits and ground	2 kV (1 min.) - 2.2kV (1 s)
between open contact parts	2 kV (1 min.) - 2.2kV (1 s)
between adjacent contacts	2 kV (1 min.) - 2.2kV (1 s)
Impulse withstand voltage (1,2/50μs - 0,5J) between electrically independent circuits and between these circuits and ground	5 kV
between open contact parts	5 kV

MECHANICAL SPECIFICATIONS

Mechanical life expectancy	10x10 ⁶ operations
Maximum mechanical switching rate	3,600 operations/h
Degree of protection	IP50 fitted to socket
Dimensions (mm)	45x90x100 ⁽¹⁾
Weight (g)	380

(1) Output terminals excluded.

ENVIRONMENTAL SPECIFICATIONS

Standard operating temperature	standard	-25 to +55°C
Version for railways, rolling stock (RMGR)		-25 to +70°C (+85°C for 10 min) -40°C as option
Storage and shipping temperature		-25 to +85°C
Relative humidity		Standard: 75% RH - Tropicalized: 95% RH
Fire behaviour		V0

STANDARDS AND REFERENCE VALUES

EN 61810-1	Electromechanical elementary relays Part 1: General and safety requirements
EN 61810-7	Electromechanical elementary relays Part 7: Test and measurement procedures
EN 61810-3, type A ⁽¹⁾	Electromechanical elementary relays Part 3: Relays with forcibly guided (mechanically linked) contacts ⁽²⁾
EN 60695-2-10	Fire hazard testing Part 2-10: Glowing/hot-wire based test methods
EN 61000	Electromagnetic compatibility
EN 60529	Degrees of protection provided by enclosures (IP Code)

Unless otherwise specified, the products are designed and manufactured according to the requirements of the above-mentioned European and International standards.

In accordance with EN 61810-1, all technical data are referred to ambient temperature of 23°C, atmospheric pressure of 96kPa and 50% humidity.
Tolerance for coil resistance and nominal power is 5%.

(1) Gap verification as per method described at §5.3.11 b.

(2) Vibration resistance, frequency range, $f = 10 \div 200$ Hz - no contact opening up to 0.828G
Shocks resistance: 15 G - no damages**RAILWAYS, ROLLING STOCK - STANDARDS APPLICABLE TO RMGR VERSIONS**

EN 60077-2	Railway applications - Electric equipment for rolling stock Part 2: Electrotechnical components - General rules
EN 50155	Railway applications - Rolling stock - Electronic equipment - T3 class Testing
EN 61373	Railway applications - Rolling stock equipment - Shock and vibration tests, Cat 1, Classe B Vibration resistance, frequency range $f = 5 \div 150$ Hz ⁽¹⁾
EN 45545-2	Railway applications - Fire protection on railway vehicles Part 2: Requirements for fire behavior of materials and components HL3: Cat E10 (R26 requirement)
ASTM E162, E662, E1354	Fire behavior - Standard test method
BSS7239	Fire behavior - Toxicity Test

(1) At de-energized relay: no contact opening > 3ms



CONFIGURATIONS - OPTIONS

TROPICALIZATION	Surface treatment of coil with protective coating for use in conditions of RH 95%. This treatment serves to give the coil added protection against corrosion that could occur as a result of moisture reacting with certain chemical agents such as those found in acid or saline atmospheres.
GOLD PLATING	Surface treatment of contacts, blades and output terminals with gold, thickness $\geq 2\mu$. This treatment ensures long-term capacity of the contact to conduct low levels of current, even in adverse ambient conditions.
LED	LED indicator showing presence of power supply, wired in parallel with the coil.
FLYBACK DIODE	Component connected in parallel with the coil designed to suppress overvoltages generated by the coil when de-energized.
LOW TEMPERATURE	Minimum operating temperature -40°C , only for rolling stock version (option "L").



ORDERING SCHEME

PRODUCT CODE	APPLICATION ⁽¹⁾	CONFIGURATION A	CONFIGURATION B	TYPE OF POWER SUPPLY	NOMINAL VOLTAGE (V) ⁽²⁾	FINISH ⁽³⁾	KEYING POSITION CODE ⁽⁴⁾
RMG	E: Energy F: Railway Fixed Equipment R: Railway Rolling stock	1: Standard 2: Gold plating + Diode // + Led 3: Diode // 4: Gold plating 5: Led 6: Gold plating + Diode // 7: Diode // + Led	2X: 6 SPDT contacts + 2 NO 6X: 6 SPDT contacts + 2 NO with magnetic arc blow-out	C: Vdc	024 - 036 - 048 072 - 096 - 110 125 - 132 - 220	T: Tropicalized coil L: Low temperature	XX

Example	RMG	E	3	6X	C	048	T	
	RMGE36X-C048/T = ENERGY series relay with back EMF suppression diode, magnetic arc blow-out and 48Vdc tropicalized coil.							
	RMG	R	7	2X	C	110		
RMGR72X-C110 = RAILWAY series relay, equipped with flyback diode and indicator Led and 110Vdc coil.								

- ENERGY:** all applications except for railway.
RAILWAYS, FIXED EQUIPMENT: application on fixed power systems and electrical railway traction. Construction according to RFI (FS Group, Italy) specification n° RFI DPRIM STF IFS TE 143 A, if applicable for list of RFI approved and conforming products, consult dedicated catalogue "RAILWAY SERIES - RFI APPROVED"
RAILWAYS, ROLLING STOCK: Application on board rolling stock. Electrical characteristics according to EN60077.
- Other values on request.
- Optional value.
- Optional value. The positive mechanical keying is applied according to the manufacturer's model.



WIRING DIAGRAM

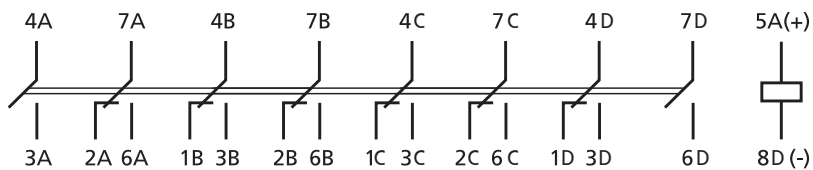

DIMENSIONS

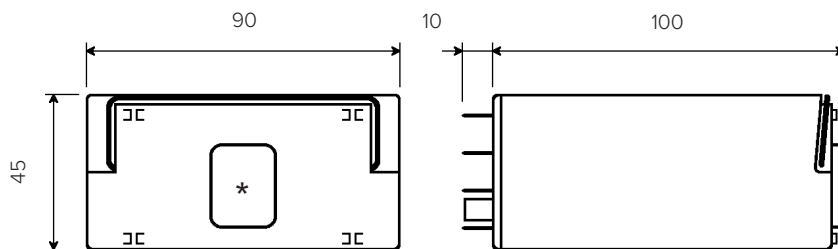

RMG.x2X - RMG.x6X

(*) access to the manual operating lever

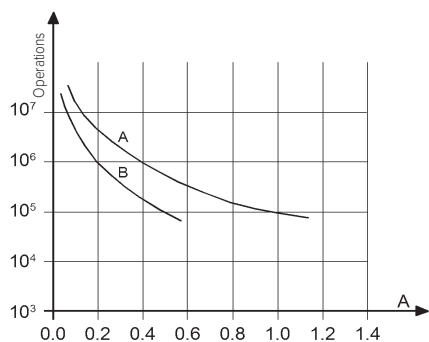

Contact loading: 110Vdc, L/R 40 ms
 Curve A: RMG.x6X
 Curve B: RMG.x2X

RMG.x2X			
U	I (A)	L/R (ms)	Operations
110Vdc	0.5	40	100,000
110Vdc	0.6	10	300,000
120Vdc	0.7	40	50,000
125Vdc	1.2	0	1,000,000
220Vdc	0.1	40	100,000
220Vdc	0.25	10	100,000
U	I (A)	cosφ	Operations
110Vac	1	1	2,000,000
110Vac	1	0.5	1,500,000
110Vac	5	1	1,000,000
110Vac	5	0.5	500,000
220Vac	0.5	1	2,000,000
220Vac	1	0.5	600,000
220Vac	5	1	650,000
220Vac	5	0.5	600,000

RMG.x6X			
U	I (A)	L/R (ms)	Operations
24Vdc	1	0	7,000,000
24Vdc	1	40	3,000,000
24Vdc	2	40	2,000,000
24Vdc	5	0	3,000,000
24Vdc	5	40	200,000
24Vdc	9	0	800,000
48Vdc	5	20	200,000
110Vdc	0.4	40	1,000,000
110Vdc	1	40	100,000
110Vdc	10	0	100,000
U	I (A)	cosφ	Operations
220Vac	5	0.5	100,000
220Vac	10	1	100,000
230Vac	1	0.7	2,500,000
230Vac	3	0.7	1,200,000

Switching frequency: 1,200 operations/hour

SOCKETS AND RETAINING CLIPS

RETAINING CLIP



Type of installation	Type of outputs	Model	
Wall or DIN rail mounting	Screw	96IP20-I DIN	RMC48
	Spring clamp	PAIR320	
Flush mounting	Double faston (4.8 x 0.8 mm)	ADF4-E1	
	Spring clamp	PRIR321	

INSTALLATION, OPERATION AND MAINTENANCE



Installation

Before installing the relay on a wired socket, disconnect the power supply.

The preferential mounting position is on the wall, with the relay positioned horizontally in the "reading orienting" of marking so that the label is readable in the correct sense.

Spacing: the distance between adjacent relays depends on use' conditions.

If a relay is used in the "less favorable" conditions that occur with "simultaneously":

- Power supply: the maximum allowed, permanently
- Ambient temperature: the maximum allowed, permanently
- Current on the contacts: the maximum allowed, permanently
- Number of contacts used: 100%

it is strongly recommended to space relay at least 5 mm horizontally and 20 mm vertically, to allow for proper upward heat' dissipation and increase the longevity of the component.

Actually, relays could be used in less severe conditions. In this case, the distance between adjacent relays can be reduced or abolished. A correct interpretation of the use' conditions allows the optimization of the available spaces. Contact AMRA for more information.

To increase relay' longevity, we recommend mounting relays intended for "continuous use" (permanent power supply), alternating them with relays intended for less frequent use.

For a safe use, the retaining clip is recommended. For use on rolling stock, relays have been tested to EN 61373 standard equipped with retaining clip(s).

Operation

Before use: if relay is not used, for example after long storage periods, contact resistance may increase due to a natural and slight oxidation or polluting deposits.

In order to restore the optimal conductivity and for standard contacts (NOT gold plated) it is recommended to switch several time a load of at least 110Vdc - 100mA or 24Vdc - 500mA. The contacts will be "cleaned" thanks to the electric arc generated during the current interruption and the mechanical self-cleaning action.

The common contact rubs against the fixed poles (NO and NC contacts) both when opening and when closing, which ensures a self-cleaning action.

An increase in contacts' resistance, in most cases, does not represent a problem. Many factors contribute to the correct use of contact and consequently to the relay' long-term reliability:

- **Load:** the current switching generates an electric arc with cleaning effects. For proper electrical cleaning and performance keeping we recommend:
 - o Standard contacts: Minimum current = 20mA
 - o Gold plated contacts: Minimum current = 10mA
- **Operating frequency:** relays are components that can operate with a wide range of switching frequency. High frequency operation also allows a continuous cleaning effect by "sliding" (mechanical cleaning). In case of low frequency operation (for example few time a day), we advise:
 - o Use of contact with currents twice compared to those indicated.
 - o For currents lower than 10mA, use gold plated contacts and connect 2 contacts in parallel, in order to reduce the equivalent contact resistance
- **Pollution:** the presence of pollution can cause impurities on contact surface. Electric charges attract organic molecules and impurities that are deposited on the contact surface. Electrical and mechanical cleaning, respectively, burn and remove such impurities. In pollution presence, the minimum recommended currents must be respected. In extreme cases, provide double the cleaning current.

Condensation is possible inside the relay when energized and the outside ambient temperature is cold; this is quite normal and does not affect the operation of the relay. Plastic materials of relay do not possess hygroscopic properties.

Maintenance

No maintenance is required.

In case of normal relay wear (reaching the end of electrical or mechanical life), the relay cannot be restored and must be replaced.

To check the component, relay removal must be carried out with slight lateral movements. An "up and down" movement can cause terminals damage.

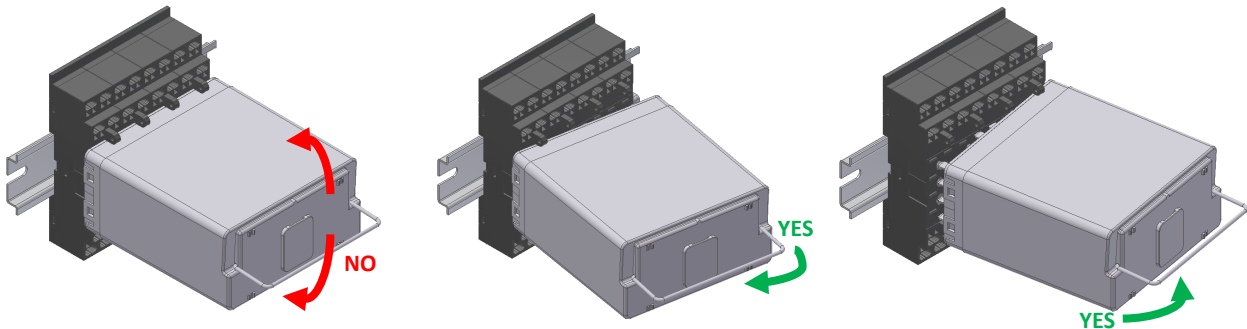

Often the malfunctions are caused by power supply with inverted polarity, by external events or by use with loads exceeding the contact performance.

In case of suspected malfunction, energize relay and observe if mechanical operation of contacts / relay mechanism is performed. Pay attention to the power supply polarity, if relay is equipped with polarized components (example: diode, led).

- In case of expected operation, clean the contacts (see paragraph "OPERATION") and check if the circuit load ranges within the contact performance. If necessary, replace with relays with gold contacts. Note: the electrical continuity of contacts must be checked with adequate current.
- If it does not work, we recommend to use a relay of the same model and configuration.

If an investigation by AMRA is required, pull-out the relay from the socket, don't remove the cap, avoid any other manipulation and contact us. You will be asked for the following data: environmental conditions, power supply, switching frequency, contact load, number of operations performed.

The fault can be described through the "TECHNICAL SUPPORT" section of the website www.amra-chauvin-arnoux.it.

In any case, the relay cannot be repaired by the user.

Storage

Storage conditions must guarantee the environmental conditions (temperature, humidity and pollution) required for the product conservation, in order to avoid deterioration.

The product must be stored in an environment sheltered from atmospheric agents and not polluted, with an ambient temperature between -25 and +85°C with max 75% RH. Humidity can reach peaks of 95%. In any case, there must be no condensation. Before use, please read carefully "OPERATION" section.

RMGW

INSTANTANEOUS RELAYS, WELD-NO-TRANSFER 8 CONTACTS

FORCIBLY GUIDED CONTACTS

APPLICATIONS



Shipbuilding



Petroleum industry



Heavy industry



Power generation



Power distribution



Railway equipment



Rolling stock



OVERVIEW

- Forcibly guided (mechanically linked) contacts, as per standard **NF 62-002 (§12.3.10)**
- Weld-no-transfer technology
- Plug-in monostable instantaneous relays
- Suitable for safety applications
- Solid and rugged construction for heavy or intensive duty
- Self-cleaning knurled contacts
- Very high electrical life expectancy and exceptional endurance
- Magnetic arc blow-out (optional) for higher breaking capacity
- Wide option range: signalling LED, FLYBACK DIODE, varistor, etc.
- Transparent cover, with access for manual operation (standard) and pull-out handle
- Retaining clip for secure locking of relay on socket

DESCRIPTION

RMGW relays are highly reliable products featuring high performance, suitable for applications in very harsh and disturbed environments such as **ROLLING STOCK** applications.

Forcibly guided contacts are tested as per standard **NF F62002 (§12.3.10)**. Forcibly guided contacts are also known as weld-no-transfer contacts.

Equipped by 8 C/O contacts: the user have the greatest possible flexibility in designing (6 NC + 2 NO, 5 NC + 3 NO, etc.).

Wide contact gap for a very high breaking capacity, electrical life expectancy and insulation.

The operating temperature range is -40°C to +85°C . RMG can operate in environment with high thermal shocks.

Manual operation as standard for all models, allowing tests to be conducted in the absence of any power supply.

The contacts are designed to obtain remarkable performances both for high, inductive loads or very low loads. Each contact is able to switch from 5mA – 10V even without contact gilding

The knurled surface ensures an excellent self-cleaning effect, a lower ohmic resistance thanks to the various points of electrical contact, and will also improve the electrical life of the component.

The magnetic arc blow-out contributes to increase breaking capacity: the relay is suitable for controlling heavy duty loads with intensive switching frequency.

In this relay range, with forcibly guided contact (mechanically linked) special design and constructional measures are used to ensure that make (NO) contacts cannot assume the same state as break (NC) contacts.

Testing method is according to **NF F62002 (§12.3.10)**:

- The NC contact is kept closed. Relay is energized with a voltage of 150% of U_{max} ($150\% * 125\% U_{nom} = 188\% U_{nom}$). NO contact should NOT close with a test load of 220V 50Hz, 10 mA.
- The NO contact is kept closed. NC contact should NOT close with a test load of 220V 50Hz, 10 mA.

STANDARD COMPLIANCE

EN 61810-3	ASTM E162, E662
EN 60077	EN 61810-1
EN 50155	EN 61810-7
EN 61373	EN 60695-2-10
EN 45545-2	EN 60529

MODELS	NUMBER OF CONTACTS	MAGNETIC ARC BLOW-OUT
RMG.x2W	8 SPDT	
RMG.x6W	8 SPDT	•

FOR PRODUCT CODE CONFIGURATION, SEE THE "ORDERING SCHEME" TABLE

COIL DATA	RMGExyW - RMGFxyW	RMGRxyW
Nominal voltages Un	DC : 24-48-110-125-132-220 ⁽¹⁾	DC : 24-36-72-96-110 ⁽²⁾
Consumption at Un (DC/AC)	3W	
Operating range	DC : 80÷115% Un	DC : 70÷125% Un
Type of duty	Continuous	
Drop-out voltage ⁽³⁾	DC : > 5% Un	

(1) Other values on request.

(2) Suitable for application on rolling stock. Operating range in compliance with EN 60077 standard.

(3) Limit value for supply voltage, expressed as % of the nominal value, beneath which the relay is certain to be de-energized.

CONTACT DATA	RMG.12W-16W-42W-46W	RMG.32W-36W-62W-66W-52W-56W
Number and type	8 SPDT, form C	
Current	See following graph	
Nominal	20A for 1min - 40A for 1s	
Maximum peak ⁽¹⁾	150A for 10ms	
Maximum pulse ⁽¹⁾		
Example of electrical life expectancy	RMG.x2W : 0.5A - 110Vdc - L/R 40ms - 10 ⁵ operations - 1.800 operations / hour RMG.x6W : 1A - 110Vdc - L/R 40ms - 10 ⁵ operations - 1.800 operations / hour	
Minimum load ⁽²⁾	Standard contacts	200mW (10V, 10mA)
	Gold-plated contacts ⁽³⁾	50mW (5V, 5mA)
Maximum breaking voltage	350 VDC / 440 VAC	
Contact material	AgCdO	
Operating time at Un (ms) ⁽⁴⁾	DC	
Pick-up (NC contact opening)	≤ 20	
Pick-up (NO contact closing)	≤ 40	
Drop-out (NO contact opening)	≤ 6	
Drop-out (NC contact closing):	≤ 60	

(1) Maximum peak and pulse currents are those currents that can be handled, for a specified time, by the contact. They do not refer to steady or interrupted currents.

(2) Values referred to a new product, measured in laboratory. The ability to maintain this performance over the time depends on the environmental conditions and the contact' frequency use. The use of gold plated contacts is recommended in the case of very low loads.

(3) A gold contact, if subjected to high loads, degrades superficially. In this case, the characteristics of the standard contact must be considered. This does not affect the operation of the relay.

(4) Unless specified otherwise, the operating time signifies until stabilization of the contact (including bounces).

RATED CURRENT CONTACTS

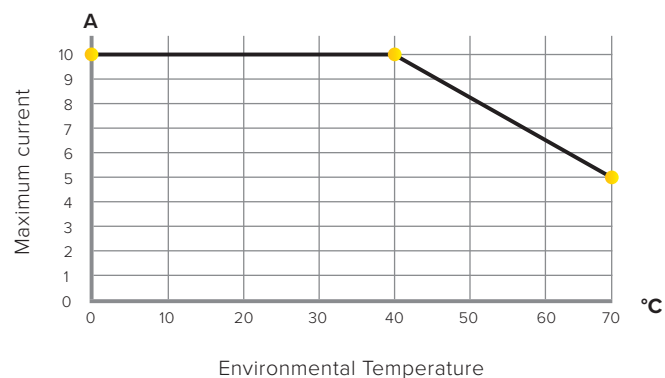

Note: reduction of 30% on all the contacts simultaneously.

INSULATION



Insulation resistance (at 500VCD)	
between electrically independent circuits and between these circuits and ground	> 10.000 MΩ
between open contact parts	> 10.000 MΩ
Withstand voltage at industrial frequency	
between electrically independent circuits and between these circuits and ground	2 kV (1 min.) - 2,2kV (1 s)
between open contact parts	2 kV (1 min.) - 2,2kV (1 s)
between adjacent contacts	2 kV (1 min.) - 2,2kV (1 s)
Impulse withstand voltage (1,2/50μs - 0,5J)	
between electrically independent circuits and between these circuits and ground	5 kV
between open contact parts	5 kV

MECHANICAL SPECIFICATIONS



Mechanical life expectancy	10x10 ⁶ operations
Maximum mechanical switching rate	3600 operations/h
Degree of protection	IP50 fitted to socket
Dimensions (mm)	45x90x100 ⁽¹⁾
Weight (g)	380

(1) Output terminals excluded.

ENVIRONMENTAL SPECIFICATIONS



Standard operating temperature	standard	-25 to +55 °C
Version for railways, rolling stock (RMGR)		-25 to +70°C (+85°C for 10 min) -40°C as option
Storage and shipping temperature		-25 to +85°C
Relative humidity		Standard: 75% RH - Tropicalized: 95% RH
Fire behaviour		V0

STANDARDS AND REFERENCE VALUES



EN 61810-1, EN 61810-2, EN 61810-7	All-or-nothing relays
EN 60695-2-10	Fire behaviour
EN 60529	Degree of protection provided by enclosures

Unless otherwise specified, products are designed and manufactured to the requirements of the European and International standards indicated above.

In accordance with EN 61810-1, all items of technical data are referred to ambient temperature 23 °C, atmospheric pressure 96kPa and 50% humidity.

Tolerance for coil resistance, nominal electrical input and nominal power is ±7%.

RAILWAYS, ROLLING STOCK - STANDARDS APPLICABLE TO RMGRX VERSION



EN 60077	Electric equipment for rolling stock - General service conditions and general rules
EN 50155	Electronic equipment used on rolling stock
EN 61373 ⁽¹⁾	Shock and vibration tests, cat 1, class B
NF F62-002 (§12.3.10)	Weld-no-transfer contacts, test method
EN 45545-2	Fire behaviour, cat E10, requirement R26, V0
ASTM E162, E662	Fire behaviour

(1) Opening of NC contacts allowed only at de-energized relay t<3ms.

CONFIGURATIONS - OPTIONS



TROPICALIZATION	Surface treatment of coil with protective coating for use in conditions of RH 95%. This treatment serves to give the coil added protection against corrosion that could occur as a result of moisture reacting with certain chemical agents such as those found in acid or saline atmospheres.
GOLD PLATING	Surface treatment of contacts, blades and output terminals with gold, thickness ≥ 2μ. This treatment ensures long-term capacity of the contact to conduct low levels of current, even in adverse ambient conditions.
LED	LED indicator showing presence of power supply, wired in parallel with the coil.
FLYBACK DIODE	Component connected in parallel with the coil designed to suppress overvoltages generated by the coil when de-energized.
LOW TEMPERATURE	Minimum operating temperature -40°C, only for rolling stock version (option "L").



ORDERING SCHEME

PRODUCT CODE	APPLICATION ⁽¹⁾	CONFIGURATION A	CONFIGURATION B	TYPE OF POWER SUPPLY	NOMINAL VOLTAGE (V) ⁽²⁾	FINISH ⁽³⁾	KEYING POSITION CODE ⁽⁴⁾
RMG	E: Energy F: Railway Fixed Equipment R: Railway Rolling stock	1: Standard 2: Gold plating + Diode // + Led 3: Diode // 4: Gold plating 5: Led 6: Gold plating + Diode // 7: Diode // + Led 9: Transil + Led	2W: 8 SPDT contacts 6W: 8 SPDT contacts with magnetic arc blow-out	C: Vdc	024 - 036 - 048 072 - 096 - 110 125 - 132 - 220	T: Tropicalized coil L: Low temperature	XX

Example

RMG	E	3	6W	C	048	T	
RMGE36W-C048/T = ENERGY series relay with back EMF suppression diode, magnetic arc blow-out and 48Vdc tropicalized coil.							
RMG	R	7	2W	C	110		
RMGR72W-C110 = RAILWAY series relay, equipped with flyback diode and indicator Led and 110Vdc coil.							

- ENERGY:** all applications except for railway.
RAILWAYS, FIXED EQUIPMENT: application on fixed power systems and electrical railway traction. Construction according to RFI (FS Group, Italy) specification n° RFI DPRIM STF IFS TE 143 A, if applicable for list of RFI approved and conforming products, consult dedicated catalogue "RAILWAY SERIES - RFI APPROVED"
RAILWAYS, ROLLING STOCK: Application on board rolling stock. Electrical characteristics according to EN60077.
- Other values on request.
- Optional value.
- Optional value. The positive mechanical keying is applied according to the manufacturer's model.



WIRING DIAGRAM

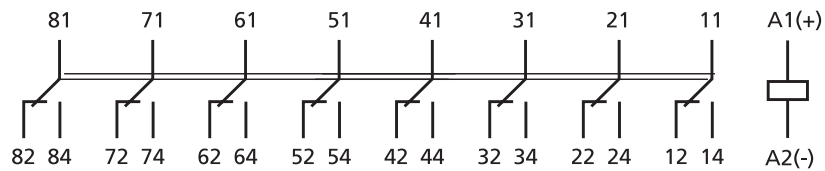

DIMENSIONS

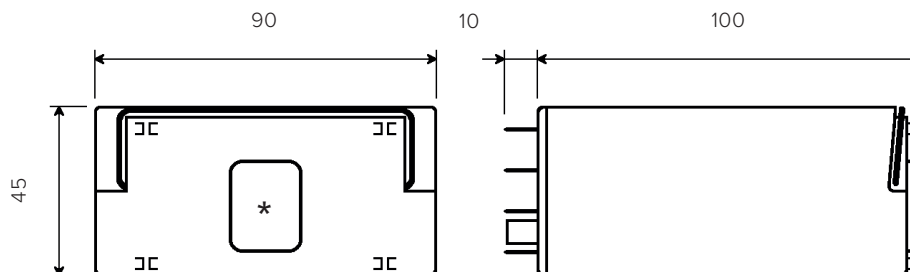

(*) access to the manual operating lever

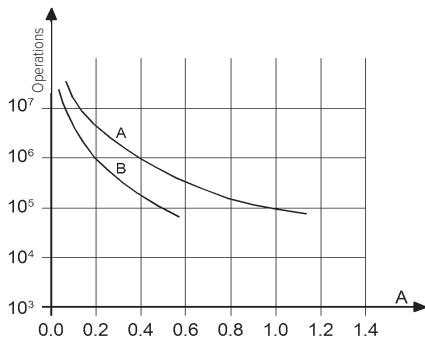

Contact loading: 110Vdc, L/R 40 ms

Curve A: RMG.x6W

Curve B: RMG.x2W

RMG.x2W			
U	I (A)	L/R (ms)	Operations
110Vdc	0.5	40	100,000
110Vdc	0.6	10	300,000
120Vdc	0.7	40	50,000
125Vdc	1.2	0	1,000,000
220Vdc	0.1	40	100,000
220Vdc	0.25	10	100,000
U	I (A)	cosφ	Operations
110Vac	1	1	2,000,000
110Vac	1	0.5	1,500,000
110Vac	5	1	1,000,000
110Vac	5	0.5	500,000
220Vac	0.5	1	2,000,000
220Vac	1	0.5	600,000
220Vac	5	1	650,000
220Vac	5	0.5	600,000

RMG.x6W			
U	I (A)	L/R (ms)	Operations
24Vdc	1	0	7,000,000
24Vdc	1	40	3,000,000
24Vdc	2	40	2,000,000
24Vdc	5	0	3,000,000
24Vdc	5	40	200,000
24Vdc	9	0	800,000
48Vdc	5	20	200,000
110Vdc	0.4	40	1,000,000
110Vdc	1	40	100,000
110Vdc	10	0	100,000
U	I (A)	cosφ	Operations
220Vac	5	0.5	100,000
220Vac	10	1	100,000
230Vac	1	0.7	2,500,000
230Vac	3	0.7	1,200,000

Switching frequency: 1200 operations/hour

SOCKETS AND RETAINING CLIPS

RETAINING CLIP



Type of installation	Type of outputs	Model	
Wall or DIN rail mounting	Screw	96IP20-I DIN	RMC48
	Spring clamp	PAIR320	
Flush mounting	Double faston (4.8 x 0.8 mm)	ADF4-E1	
	Spring clamp	PRIR321	

INSTALLATION, OPERATION AND MAINTENANCE



Installation

Before installing the relay on a wired socket, disconnect the power supply.

The preferential mounting position is on the wall, with the relay positioned horizontally in the "reading orienting" of marking so that the label is readable in the correct sense.

Spacing: the distance between adjacent relays depends on use' conditions.

If a relay is used in the "less favorable" conditions that occur with "simultaneously":

- Power supply: the maximum allowed, permanently
- Ambient temperature: the maximum allowed, permanently
- Current on the contacts: the maximum allowed, permanently
- Number of contacts used: 100%

it is strongly recommended to space relay at least 5 mm horizontally and 20 mm vertically, to allow for proper upward heat' dissipation and increase the longevity of the component.

Actually, relays could be used in less severe conditions. In this case, the distance between adjacent relays can be reduced or abolished. A correct interpretation of the use' conditions allows the optimization of the available spaces. Contact AMRA for more information.

To increase relay' longevity, we recommend mounting relays intended for "continuous use" (permanent power supply), alternating them with relays intended for less frequent use.

For a safe use, the retaining clip is recommended. For use on rolling stock, relays have been tested to EN 61373 standard equipped with retaining clip(s).

Operation

Before use: if relay is not used, for example after long storage periods, contact resistance may increase due to a natural and slight oxidation or polluting deposits.

In order to restore the optimal conductivity and for standard contacts (NOT gold plated) it is recommended to switch several time a load of at least 110Vdc - 100mA or 24Vdc - 500mA. The contacts will be "cleaned" thanks to the electric arc generated during the current interruption and the mechanical self-cleaning action.

The common contact rubs against the fixed poles (NO and NC contacts) both when opening and when closing, which ensures a self-cleaning action.

An increase in contacts' resistance, in most cases, does not represent a problem. Many factors contribute to the correct use of contact and consequently to the relay' long-term reliability:

- **Load:** the current switching generates an electric arc with cleaning effects. For proper electrical cleaning and performance keeping we recommend:
 - o Standard contacts: Minimum current = 20mA
 - o Gold plated contacts: Minimum current = 10mA
- **Operating frequency:** relays are components that can operate with a wide range of switching frequency. High frequency operation also allows a continuous cleaning effect by "sliding" (mechanical cleaning). In case of low frequency operation (for example few time a day), we advise:
 - o Use of contact with currents twice compared to those indicated.
 - o For currents lower than 10mA, use gold plated contacts and connect 2 contacts in parallel, in order to reduce the equivalent contact resistance
- **Pollution:** the presence of pollution can cause impurities on contact surface. Electric charges attract organic molecules and impurities that are deposited on the contact surface. Electrical and mechanical cleaning, respectively, burn and remove such impurities. In pollution presence, the minimum recommended currents must be respected. In extreme cases, provide double the cleaning current.

Condensation is possible inside the relay when energized and the outside ambient temperature is cold; this is quite normal and does not affect the operation of the relay. Plastic materials of relay do not possess hygroscopic properties.

Maintenance

No maintenance is required.

In case of normal relay wear (reaching the end of electrical or mechanical life), the relay cannot be restored and must be replaced.

To check the component, relay removal must be carried out with slight lateral movements. An "up and down" movement can cause terminals damage.

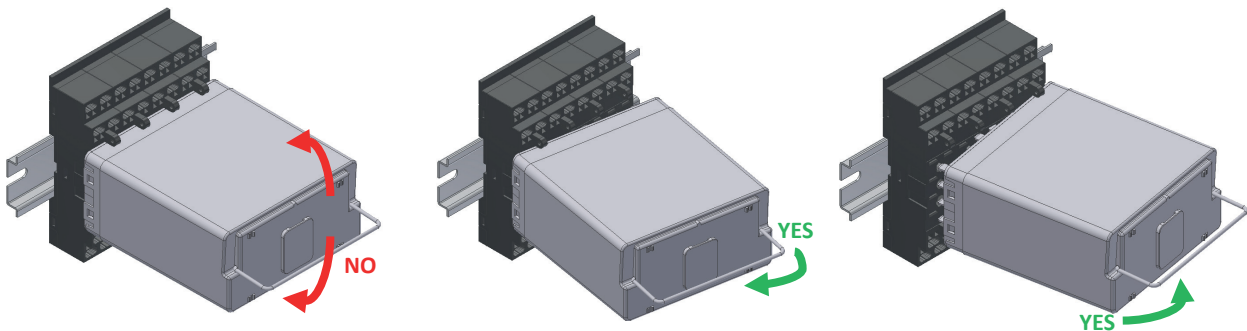

Often the malfunctions are caused by power supply with inverted polarity, by external events or by use with loads exceeding the contact performance.

In case of suspected malfunction, energize relay and observe if mechanical operation of contacts / relay mechanism is performed. Pay attention to the power supply polarity, if relay is equipped with polarized components (example: diode, led).

- In case of expected operation, clean the contacts (see paragraph "OPERATION") and check if the circuit load ranges within the contact performance. If necessary, replace with relays with gold contacts. Note: the electrical continuity of contacts must be checked with adequate current.
- If it does not work, we recommend to use a relay of the same model and configuration.

If an investigation by AMRA is required, pull-out the relay from the socket, don't remove the cap, avoid any other manipulation and contact us. You will be asked for the following data: environmental conditions, power supply, switching frequency, contact load, number of operations performed.

The fault can be described through the "TECHNICAL SUPPORT" section of the website www.amra-chauvin-arnoux.it.

In any case, the relay cannot be repaired by the user.

Storage

Storage conditions must guarantee the environmental conditions (temperature, humidity and pollution) required for the product conservation, in order to avoid deterioration.

The product must be stored in an environment sheltered from atmospheric agents and not polluted, with an ambient temperature between -25 and +85°C with max 75% RH. Humidity can reach peaks of 95%. In any case, there must be no condensation. Before use, please read carefully "OPERATION" section.

RGK

MULTISCALE TIME RELAY, WELD-NO-TRANSFER 4 CONTACTS

FORCIBLY GUIDED CONTACTS

APPLICATIONS



Shipbuilding



Petroleum industry



Heavy industry



Power generation



Power distribution



Railway equipment



Rolling Stock

OVERVIEW

- Plug-in monostable timed delay relays, “pick-up” or “drop-out” function
- Forcibly guided (mechanically linked) contacts, relays compliant with **EN 61810-3, type A**
- Weld-no-transfer technology
- Wide time delay range, from 0.1s to more than 16 hours
- Great accuracy over the entire adjustment range
- Suitable for safety applications
- Operation with d.c. and/or a.c. power supply
- Self-cleaning knurled contacts, C/O type
- Magnetic arc blow-out for higher breaking capacity
- Led optical indicators monitoring power supply and timer status

DESCRIPTION

RGK relay are highly reliable products featuring high performance, suitable for applications in very harsh and disturbed environments, such as **ROLLING STOCK** applications.

Referring to the standard **EN61810-3**, these relays are classified as fully compliant and identified as **type A** relays, (all the contacts are mechanically linked). Forcibly guided contacts are also known as weld-no-transfer contacts.

Wide contact gap for a very high breaking capacity, electrical life expectancy and insulation.

Time delay is guaranteed by high reliability electronic. The electronic is immune to strong EMC interference, typical of high voltage electricity distribution stations.

Time delay from 0.1s to over 16 hours, with extreme accuracy over the entire setting range. Intermediate scales are available, selectable by means of rotary switches. The timing function is selectable by user: “pick-up” or “drop-out”.

The contacts are designed to obtain remarkable performances both for high, inductive loads or very low loads. Each contact is able to switch from 5mA – 10V even without contact gilding.

The knurled surface ensures an excellent self-cleaning effect, a lower ohmic resistance thanks to the various points of electrical contact, and will also improve the electrical life of the component.

The magnetic arc blow-out contributes to increase breaking capacity: the relay is suitable for controlling heavy duty loads with intensive switching frequency.

In this relay range, with forcibly guided contacts (mechanically linked) special design and constructional measures are used to ensure that make (NO) contacts cannot assume the same state as break (NC) contacts.

- If, when powering up a relay, a NC contact fails to open, the remaining NO contacts must not close, maintaining a contact gap ≥ 0.5 mm

- When the relay is de-energized, if a NO contact fails to open, the remaining NC contact must not close, maintaining a contact gap ≥ 0.5 mm

In the case of relays that include changeover contacts, either the make circuit or the break circuit of a changeover contact can be considered to meet the requirements of this standard.

STANDARD COMPLIANCE

EN 61810-3	EN 61810-1
EN 60077	EN 61810-7
EN 50155	EN 60695-2-10
EN 61373	EN 61000
EN 45545-2	EN 60529
ASTM E162, E662	

MODELS	NUMBER OF CONTACTS	MAGNETIC ARC BLOW-OUT	FUNCTION
RGK.x7X	4	•	Pick-up / Drop-out

FOR PRODUCT CODE CONFIGURATION, SEE THE "ORDERING SCHEME" TABLE

COIL DATA	RGKE	RGKR
Nominal voltages Un	AC/DC : 24-36-48-72-96-110-125-230 ⁽¹⁾	
Consumption at Un (DC/AC)	3.5W	
Operating range	80...120% Un	70...125% Un
Type of duty	Continuous	
Drop-out voltage ⁽²⁾	> 5% Un	

(1) Other values on request.

(2) Limit value for supply voltage, expressed as % of the nominal value, beneath which the relay is certainly de-energized.

CONTACT DATA

Number and type	4 SPDT, form C
Current	Nominal ⁽¹⁾ 12A
	Maximum peak ⁽²⁾ 20A for 1min - 40A for 1s
	Maximum pulse ⁽²⁾ 150A for 10ms
Example of electrical life expectancy ⁽³⁾	1A - 110Vdc - L/R 40ms - 10 ⁵ operations - 1,800 operations/hour
Minimum load ⁽⁴⁾	Standard contacts 200mW (10V, 10mA)
	Gold-plated contact ⁽⁵⁾ 50mW (5V, 5mA)
Maximum breaking voltage	350 VDC / 440 VAC
Contact material	AgCdO
Operating time at Un (ms) ⁽⁶⁾	DC / AC
Pick-up (NC contact opening)	≤ 20
Pick-up (NO contact closing)	≤ 35
Drop-out (NO contact opening)	≤ 10
Drop-out (NC contact closing)	≤ 53

(1) On all contacts simultaneously, reduction of 30%.

(2) The max. peak and pulse currents are those currents that can be handled, for a specified time, by the contact. They do not refer to steady or interrupted currents.

(3) For other examples, see electrical life expectancy curves.

(4) Values referred to a new product, measured in laboratory. The ability to maintain this performance over the time depends on the environmental conditions and the contact' frequency use. The use of gold plated contacts is recommended in the case of very low loads.

(5) A gold contact, if subjected to high loads, degrades superficially. In this case, the characteristics of the standard contact must be considered. This does not affect the operation of the relay.

(6) Unless specified otherwise, the operating time signifies until stabilization of the contact (including bounces).

INSULATION

Insulation resistance (at 500VCD)	
between electrically independent circuits and between these circuits and ground	> 10,000 MΩ
between open contact parts	> 10,000 MΩ
Withstand voltage at industrial frequency	
between electrically independent circuits and between these circuits and ground	2 kV (1 min.) - 2,2kV (1 s)
between open contact parts	2 kV (1 min.) - 2,2kV (1 s)
between adjacent contacts	2 kV (1 min.) - 2,2kV (1 s)
Impulse withstand voltage (1,2/50μs - 0,5J)	
between electrically independent circuits and between these circuits and ground	5 kV
between open contact parts	4 kV

MECHANICAL SPECIFICATIONS

Mechanical life expectancy	10x10 ⁶ operations
Maximum switching rate	Mechanical 3600 operations/h
Degree of protection	IP40
Dimensions (mm)	45x50x112 ⁽¹⁾
Weight (g)	300

1. Output terminals excluded.

ENVIRONMENTAL SPECIFICATIONS



Operating temperature	Standard	-25 to +55°C
	Version for railways, rolling stock	-25 to +70°C -40°C as option
Storage and shipping temperature		-40 to +85°C
Relative humidity		Standard : 75% RH Tropicalized : 95% RH
Fire behaviour		V0

STANDARDS AND REFERENCE VALUES



EN 61810-1	Electromechanical elementary relays Part 1: General and safety requirements
EN 61810-7	Electromechanical elementary relays Part 7: Test and measurement procedures
EN 61810-3, type A ⁽¹⁾	Electromechanical elementary relays Part 3: Relays with forcibly guided (mechanically linked) contacts ⁽²⁾
EN 60695-2-10	Fire hazard testing Part 2-10: Glowing/hot-wire based test methods
EN 61000	Electromagnetic compatibility
EN 60529	Degrees of protection provided by enclosures (IP Code)

Unless otherwise specified, the products are designed and manufactured according to the requirements of the above-mentioned European and International standards.

In accordance with EN 61810-1, all technical data are referred to ambient temperature of 23°C, atmospheric pressure of 96kPa and 50% humidity.
Tolerance for coil resistance and nominal power is 5%.

(1) Gap verification as per method described at §5.3.1.1 b.

(2) Vibration resistance, frequency range, $f = 10 \div 200$ Hz - no contact opening up to 0.828G
Shocks resistance: 15 G – no damages

RAILWAYS, ROLLING STOCK - STANDARDS APPLICABLE TO RGKR VERSIONS



EN 60077-2	Railway applications - Electric equipment for rolling stock Part 2: Electrotechnical components - General rules
EN 50155	Railway applications - Rolling stock - Electronic equipment - T3 class Testing
EN 61373	Railway applications - Rolling stock equipment - Shock and vibration tests, Cat 1, Classe B Vibration resistance, frequency range $f = 5 \div 150$ Hz ⁽¹⁾
EN 45545-2	Railway applications - Fire protection on railway vehicles Part 2: Requirements for fire behavior of materials and components HL3: Cat E10 (R26 requirement)
ASTM E162, E662, E1354	Fire behavior – Standard test method
BSS7239	Fire behavior - Toxicity Test

(1) At de-energized relay: no contact opening > 3ms

CONFIGURATIONS - OPTIONS



TROPICALIZATION	Surface treatment of the coil with protective coating for use with RH 95%.
GOLD PLATING	Surface treatment of the contacts, blades and output terminals with gold-cobalt alloy $\geq 2\mu$. This treatment ensures long-term capacity of the contact to conduct lower currents.
LOW TEMPERATURE	Minimum operating temperature -40°C, only for rolling stock version (option "L").



ORDERING SCHEME

PRODUCT CODE	APPLICATION ⁽¹⁾	CONFIGURATION A	CONFIGURATION B	TYPE OF POWER SUPPLY	NOMINAL VOLTAGE (V) ⁽²⁾	FINISH ⁽³⁾
RGK	E: Energy R: Railway, Rolling Stock	1: Standard 4: Gold plating	7X: 4 SPDT contacts with magnetic arc blow-out	T: Vdc + Vac 50Hz	024 - 036 - 048 072 - 096 - 110 125 - 230	T: Tropicalized coil L: Low temperature

Example

RGK	E	1	7X	T	048	T
RGKE17X-T048/T = ENERGY series standard relay and 48Vdc tropicalized coil.						
RGK	R	4	7X	T	110	
RGKR47X-T110 = ROLLING STOCK railway series relay, gold-plated contacts and 110Vdc coil.						

(1) **ENERGY:** all applications except for rolling stock applications.

RAILWAYS, ROLLING STOCK: application on board rolling stock (wire-rail-tramway vehicles).
Electrical characteristics according to EN60077.

(2) Other values on request.

(3) Optional value.



WIRING DIAGRAM

Pick-up diagram

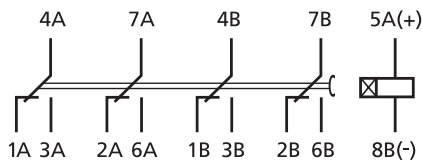

Drop-out diagram

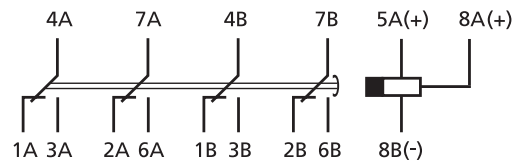

FUNCTIONAL DIAGRAM

Pick-up delay

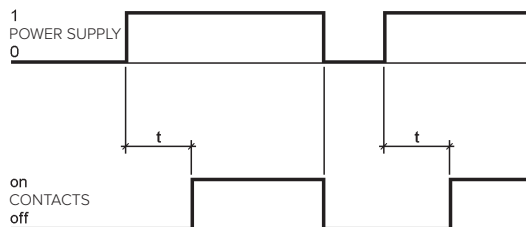

Drop-out delay

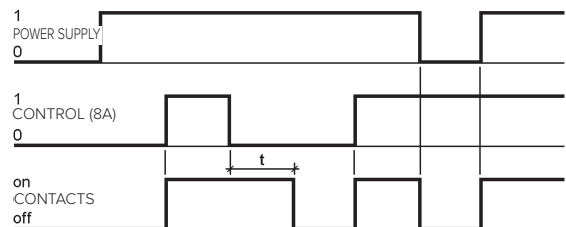



Time setting	By means of DIP switches and selectors
Time setting range	100ms...990min
Intermediate scales	6 (0.99 - 9.9 - 99 - 990 seconds / 99 - 990 minutes)
Resolution of switching time setting	1/100 of selected scale
Operating accuracy (0.8...1.1 Un, t=20°C) ⁽¹⁾	± 3 % at the beginning of scale - ±0.5 % at full scale time
Accuracy, repeatability	± 2 %
Reset	< 200ms
Insensitivity to voltage drops	< 100 ms
Indication	Red led = presence of power supply Green led = status of relay outputs (lights up with relay energized)

(1) Additional error for drop-out versions: 100 ms

Time lag and function are set through a 4-bit DIP switch and two rotary selectors located on the front of the relay (see "FRONT"). These are accessible by removing the relay identification plate.

SETTINGS – Removing the plate

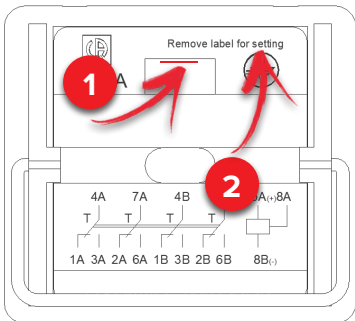
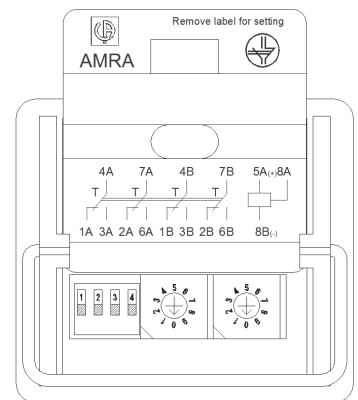
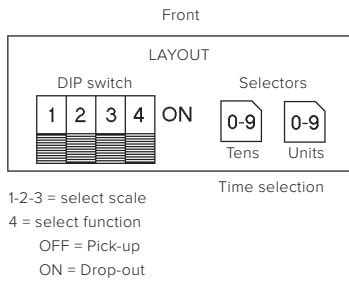

Plate is placed on the front of the cover.
To remove the plate:
1. slightly lift the plate, by acting on the point shown in picture
2. push upwards the plate.



SETTINGS – Time lag and function



SCALES / SETTING RANGE			SWITCH POSITION		
Min	Max	Unit of measure	1	2	3
10	99	Hundredths (0.01s)	OFF	ON	OFF
1	99	Tenths (0.1s)	OFF	ON	ON
1	99	Seconds	ON	OFF	OFF
1	99	Seconds x 10	ON	OFF	ON
1	99	Minutes	ON	ON	OFF
1	99	Minutes x 10	ON	ON	ON

Table 1

Function: acts on DIP switch no. 4.

- OFF: Pick-up function
- ON: Drop-out function

Time lag:

Settings are possible from 100 ms up to 990 minutes.

1. Selects the RANGE: acts on DIP switch no. 1, 2, 3.
2. Selects the TIME LAG: acts on rotary selectors

Selects the RANGE: 6 ranges are available. Move DIP switches 1, 2, 3 to "ON" or "OFF" position to obtain the desired range, as shown in TABLE 1.

1. The range should be the next higher than the value of the required time lag.

E.g. Time lag: 1'14" = 74 seconds. Closest range: 99 seconds.

Selects the TIME LAG: time lag could be set by step of 1% of the selected range. Move rotary selectors to obtain the desired time.

E.g. Time lag: 1'14" = 74 seconds. "TENS" selector on "7" + "UNIT" selector on "4".



DIMENSIONS

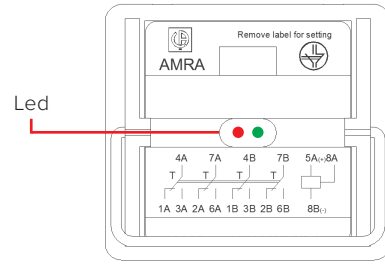
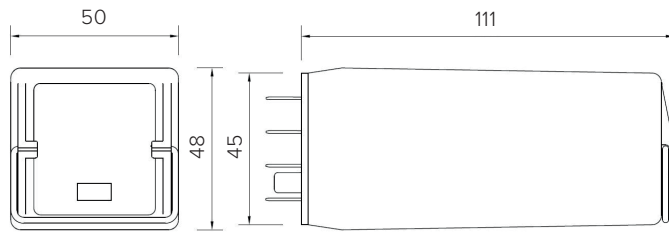

ELECTRICAL LIFE EXPECTANCY

Some examples of electrical life expectancy

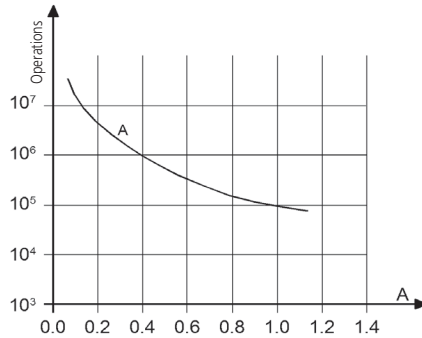

Contact loading: 110Vdc, L/R 40 ms

RGK.X7X

U	I (A)	L/R (ms)	Operations
24Vdc	1	0	7,000,000
24Vdc	1	40	3,000,000
24Vdc	2	40	2,000,000
24Vdc	5	0	3,000,000
24Vdc	5	40	200,000
24Vdc	9	0	800,000
48Vdc	5	20	200,000
110Vdc	0.4	40	1,000,000
110Vdc	1	40	100,000
110Vdc	1	40	350,000 ⁽¹⁾
110Vdc	10	0	100,000
U	I (A)	L/R (ms)	Operations
220Vac	5	0.5	100,000
220Vac	10	1	100,000
230Vac	1	0.7	2,500,000
230Vac	3	0.7	1,200,000

⁽¹⁾ 2 series contacts

Switching frequency: 1,200 operations/hour



SOCKETS AND RETAINING CLIPS

RETAINING CLIP

Type of installation	Type of outputs	Model	
Wall or DIN rail mounting	Screw	48BIP20-I DIN	RGL48
	Spring clamp	PAIR160	
Flush mounting	Double faston	PRIR160	
	Double faston (4.8 x 0.8 mm)	ADF2	



INSTALLATION, OPERATION AND MAINTENANCE

Installation

Before installing the relay on a wired socket, disconnect the power supply.

The preferential mounting position is on the wall, with the relay positioned horizontally in the "reading orienting" of marking so that the label is readable in the correct sense.

Spacing: the distance between adjacent relays depends on use' conditions.

If a relay is used in the "less favorable" conditions that occur with "simultaneously":

- Power supply: the maximum allowed, permanently
- Ambient temperature: the maximum allowed, permanently
- Current on the contacts: the maximum allowed, permanently
- Number of contacts used: 100%

it is strongly recommended to space relay at least 5 mm horizontally and 20 mm vertically, to allow for proper upward heat' dissipation and increase the longevity of the component.

Actually, relays could be used in less severe conditions. In this case, the distance between adjacent relays can be reduced or abolished. A correct interpretation of the use' conditions allows the optimization of the available spaces. Contact AMRA for more information.

To increase relay' longevity, we recommend mounting relays intended for "continuous use" (permanent power supply), alternating them with relays intended for less frequent use.

For a safe use, the retaining clip is recommended. For use on rolling stock, relays have been tested to EN 61373 standard equipped with retaining clip(s).

Operation

Before use: if relay is not used, for example after long storage periods, contact resistance may increase due to a natural and slight oxidation or polluting deposits.

In order to restore the optimal conductivity and for standard contacts (**NOT gold plated**) it is recommended to switch several time a load of at least 110Vdc - 100mA or 24Vdc - 500mA. The contacts will be "cleaned" thanks to the electric arc generated during the current interruption and the mechanical self-cleaning action.

The common contact rubs against the fixed poles (NO and NC contacts) both when opening and when closing, which ensures a self-cleaning action.

An increase in contacts' resistance, in most cases, does not represent a problem. Many factors contribute to the correct use of contact and consequently to the relay' long-term reliability:

- **Load:** the current switching generates an electric arc with cleaning effects. For proper electrical cleaning and performance keeping we recommend:
 - Standard contacts: Minimum current = 20mA
 - Gold plated contacts: Minimum current = 10mA
- **Operating frequency:** relays are components that can operate with a wide range of switching frequency. High frequency operation also allows a continuous cleaning effect by "sliding" (mechanical cleaning). In case of low frequency operation (for example few time a day), we advise:
 - Use of contact with currents twice compared to those indicated.
 - For currents lower than 10mA, use gold plated contacts and connect 2 contacts in parallel, in order to reduce the equivalent contact resistance
- **Pollution:** the presence of pollution can cause impurities on contact surface. Electric charges attract organic molecules and impurities that are deposited on the contact surface. Electrical and mechanical cleaning, respectively, burn and remove such impurities. In pollution presence, the minimum recommended currents must be respected. In extreme cases, provide double the cleaning current.

Condensation is possible inside the relay when energized and the outside ambient temperature is cold; this is quite normal and does not affect the operation of the relay. Plastic materials of relay do not possess hygroscopic properties.

Maintenance

No maintenance is required.

In case of normal relay wear (reaching the end of electrical or mechanical life), the relay cannot be restored and must be replaced.

To check the component, relay removal must be carried out with slight lateral movements. An "up and down" movement can cause terminals damage.

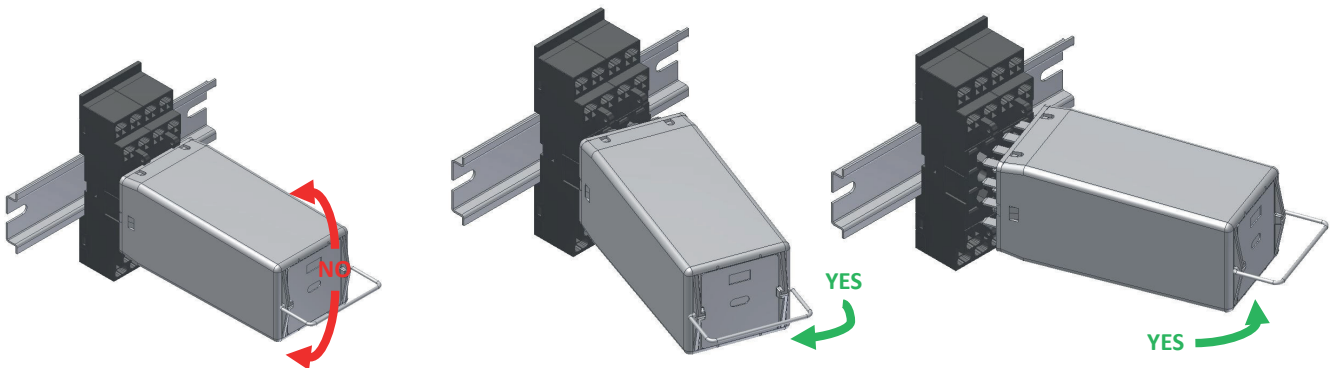

Often the malfunctions are caused by power supply with inverted polarity, by external events or by use with loads exceeding the contact performance.

In case of suspected malfunction, energize relay and observe if mechanical operation of contacts / relay mechanism is performed. Pay attention to the power supply polarity, if relay is equipped with polarized components (example: diode, led).

- In case of expected operation, clean the contacts (see paragraph "OPERATION") and check if the circuit load ranges within the contact performance. If necessary, replace with relays with gold contacts. Note: the electrical continuity of contacts must be checked with adequate current.
- If it does not work, we recommend to use a relay of the same model and configuration.

If an investigation by AMRA is required, pull-out the relay from the socket, don't remove the cap, avoid any other manipulation and contact us. You will be asked for the following data: environmental conditions, power supply, switching frequency, contact load, number of operations performed.

The fault can be described through the "TECHNICAL SUPPORT" section of the website www.amra-chauvin-arnoux.it.

In any case, the relay cannot be repaired by the user.

Storage

Storage conditions must guarantee the environmental conditions (temperature, humidity and pollution) required for the product conservation, in order to avoid deterioration.

The product must be stored in an environment sheltered from atmospheric agents and not polluted, with an ambient temperature between -40 and +85°C with max 75% RH. Humidity can reach peaks of 95%. In any case, there must be no condensation. Before use, please read carefully "OPERATION" section.

RMMX

SERIES

INSTANTANEOUS MONOSTABLE RELAYS, WITH 8 CHANGE-OVER CONTACTS

APPLICATIONS



Shipbuilding



Petroleum industry



Heavy industry



Power generation



Power distribution



Railway equipment

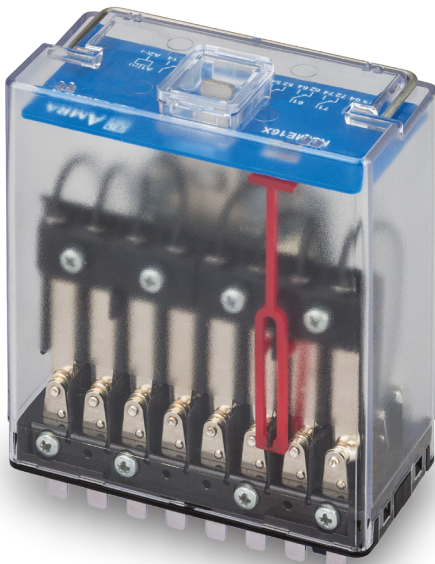

OVERVIEW

- Compact plug-in monostable instantaneous relays
- Compact dimensions than RMM Series
- Solid and rugged construction for intensive duty, IP50 protection
- Self-cleaning knurled contacts, C/O type
- New "HIGH POWER" magnetic arc blow-out for improved breaking capacity
- High electrical life expectancy and exceptional endurance
- Mechanical optical device or Led indicating energized status of coil
- Wide variety of configurations and customizations
- Retaining clip for secure locking of relay on socket
- Positive mechanical keying for relay and socket

DESCRIPTION

RMMX relays, with 8 changeover contacts, are highly reliable products featuring high performance, suitable for applications in very harsh and disturbed environments, such as per electrical transformer stations.

The construction of the relays and careful choice of the materials ensure long life and considerable ruggedness even in harsh operating environments and in the presence of strong temperature fluctuations.

Wide range of coil's nominal voltage are available. The manufacturing versatility allows to adapt power supply to customer needs.

The IP50 protection allows the relay to be used even in dusty environments, protecting contact's surface against harmful deposits, with great benefit in conducting very low loads.

Contacts are designed to obtain remarkable performances both for high, inductive loads or very low loads. Contact is able to switch from 5mA – 5V.

The knurled surface ensures an excellent self-cleaning effect, a lower ohmic resistance thanks to the various points of electrical contact, and will also improve the electrical life of the component.

Thanks to its exceptional breaking capacity, the relay is suitable for controlling heavy duty loads where safety and continuity of operation are all-important.

Manual operation is foreseen for all models, allowing tests to be conducted in the absence of any power supply.

Available options: flyback coil protection diode and gold plated contacts.

A wide range of sockets allow to find the optimal solutions for any electrical panel's construction need.

As per all AMRA relays, RMMX relays are assembled under controlled manufacturing process in which every step of production is verified by the next step in succession. 100% of relay are tested at the end of production stage.

STANDARD COMPLIANCY

EN 60695-2-10
EN 60529
EN 50082-2

EN 61810-1
EN 61810-2
EN 61810-7

MODELS	NUMBER OF CONTACTS	MAGNETIC ARC BLOW-OUT
RMM.x2X	8	
RMM.x6X	8	•

FOR PRODUCT CODE CONFIGURATION , SEE THE "ORDERING SCHEME" TABLE

COIL DATA	RMM.x2X - RMM.x6X
Nominal voltages Un	DC: 12-24-48-110-125-132-220 ⁽¹⁾ - AC: 12-24-48-110-125-230-380-440 ⁽¹⁻²⁾
Consumption at Un (DC/AC)	3 W / 6,5 VA ⁽³⁾ - 11,5 VA ⁽⁴⁾
Operating range	DC: 80 ÷ 115 % Un - AC: 85 ÷ 110% Un
Type of duty	Continuous
Drop-out voltage ⁽⁵⁾	DC: > 5% Un - AC: > 15% Un

(1) Other values on request.

(2) Maximum value, AC = 380V 50Hz - 440V 60Hz.

(3) In operation.

(4) On pick-up.

(5) Limit value for supply voltage, expressed as % of the nominal value, beneath which the relay is certain to be de-energized.

CONTACT DATA	RMM.12X-16X-42X-46X	RMM.32X-36X-52X-56X-62X-66X-72X-76X
Number and type	8 SPDT, form C	
Current	Nominal ⁽¹⁾	10A
	Maximum peak ⁽²⁾	20A for 1min - 40A for 1s
	Maximum pulse ⁽²⁾	150A for 10ms
Example of electrical life expectancy ⁽³⁾	RMMEx2X : 0,5A - 110Vdc - L/R 40ms - 10 ⁵ operations - 1,800 operations/hour RMMEx6X : 1A - 110 Vdc - L/R 40ms - 10 ⁵ operations - 1,800 operations/hour	
Minimum load ⁽⁴⁾	Standard contacts	200mW (10V, 10mA)
	Gold-plated contacts ⁽⁵⁾	50mW (5V, 5mA)
Maximum breaking voltage	350 VDC / 440 VAC	
Contact material	AgCdO	

(1) On all contacts simultaneously, reduction of 30%.

(2) Maximum peak and pulse currents are those currents that can be handled, for a specified time, by the contact. They do not refer to steady or interrupted currents.

(3) For other examples, see electrical life expectancy curves.

(4) Values referred to a new product, measured in laboratory. The ability to maintain this performance over the time depends on the environmental conditions and the contact' frequency use
The use of gold plated contacts is recommended in the case of very low loads.

(5) A gold contact, if subjected to high loads, degrades superficially. In this case, the characteristics of the standard contact must be considered. This does not affect the operation of the relay.

(6) Unless specified otherwise, the operating time signifies until stabilization of the contact (including bounces).

INSULATION	
Insulation resistance (at 500VCD) between electrically independent circuits and between these circuits and ground	> 10,000 MΩ
	between open contact parts > 10,000 MΩ
Withstand voltage at industrial frequency between electrically independent circuits and between these circuits and ground	2 kV (1 min.) - 2.2kV (1 s)
	between open contact parts 2 kV (1 min.) - 2.2kV (1 s)
	between adjacent contacts 2 kV (1 min.) - 2.2kV (1 s)
Impulse withstand voltage (1.2/50μs - 0.5J) between electrically independent circuits and between these circuits and ground	5 kV
	between open contact parts 5 kV

MECHANICAL SPECIFICATIONS

Mechanical life expectancy	20x10 ⁶ operations
Maximum mechanical switching rate	3,600 operations/h
Degree of protection	IP50 fitted to socket
Dimensions (mm)	45x90x100 ⁽¹⁾
Weight (g)	380

(1) Output terminals excluded.

ENVIRONMENTAL SPECIFICATIONS

Standard operating temperature	standard	-25 to +55°C
Storage and shipping temperature		-25 to +85°C
Relative humidity		Standard: 75% RH - Tropicalized: 95% RH
Fire behaviour		V0

STANDARDS AND REFERENCE VALUES

EN 61810-1, EN 61810-2, EN 61810-7	All-or-nothing relays
EN 60695-2-10	Fire behaviour
EN 60529	Degree of protection provided by enclosures

Unless otherwise specified, products are designed and manufactured to the requirements of the European and International standards indicated above.

In accordance with EN 61810-1, all items of technical data are referred to ambient temperature 23 °C, atmospheric pressure 96kPa and 50% humidity.

Tolerance for coil resistance, nominal electrical input and nominal power is ±7%.

CONFIGURATIONS - OPTIONS

TROPICALIZATION	Surface treatment of coil with protective coating for use in conditions of RH 95%. This treatment serves to give the coil added protection against corrosion that could occur as a result of moisture reacting with certain chemical agents such as those found in acid or saline atmospheres.
GOLD PLATING	Surface treatment of contacts, blades and output terminals with gold, thickness ≥ 2μ. This treatment ensures long-term capacity of the contact to conduct low levels of current, even in adverse ambient conditions.
LED	LED indicator showing presence of power supply, wired in parallel with the coil.
FLYBACK DIODE	Component connected in parallel with the coil designed to suppress overvoltages generated by the coil when de-energized.

ORDERING SCHEME

PRODUCT CODE	APPLICATION ⁽¹⁾	CONFIGURATION A	CONFIGURATION B	TYPE OF POWER SUPPLY	NOMINAL VOLTAGE (V) ⁽²⁾	FINISH ⁽³⁾	KEYING POSITION CODE ⁽⁴⁾
RMM	E: Energy F: Railway Fixed Equipment	1: Standard 3: Diode // 4: Gold plating 5: Led 6: Gold plating + Diode // 7: Diode // + Led	2X: 8 SPDT contacts 6X: 8 SPDT contacts with magnetic arc blow-out	C: Vdc A: Vac 50 Hz H: Vac 60 Hz	012 - 024 - 048 110 - 125 - 132 220 - 230 - 380 440	T: Tropicalized coil	XX

Example	RMM	E	4	6X	A	024	
	RMME46X-A024 = ENERGY series relay with 8 gold-plated contacts, magnetic arc blow-out and 24Vac coil						
	RMM	F	1	2X	C	110	T
	RMMF12X-C110/T = Standard RAILWAY series relay with 8 contacts and 110Vdc tropicalized coil						

1. **ENERGY:** all applications except for railway.

RAILWAYS, FIXED EQUIPMENT: application on fixed power systems and electrical railway traction. Construction according to RFI (FS Group, Italy) specification n° RFI DPRIM STF IFS TE 143 A, if applicable for list of RFI approved and conforming products, consult dedicated catalogue "RAILWAY SERIES - RFI APPROVED".

Also available is the **STATIONS** series, with ENEL approved material meeting LV15/LV16 specifications.

For list of ENEL compliant and type-approved products, consult dedicated catalogue "**STATIONS SERIES – LV15-LV16-LV20**".

2. Other values on request. Voltages 380V and 440V available as Vac only.

3. Optional value.

4. Optional value. The positive mechanical keying is applied according to the manufacturer's model.



WIRING DIAGRAM

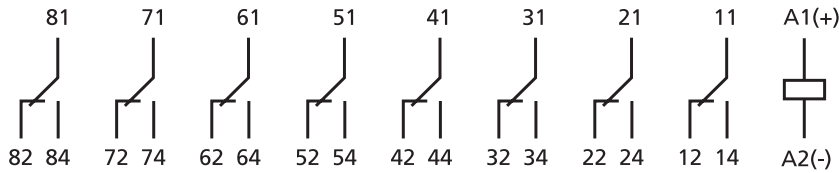

DIMENSIONS

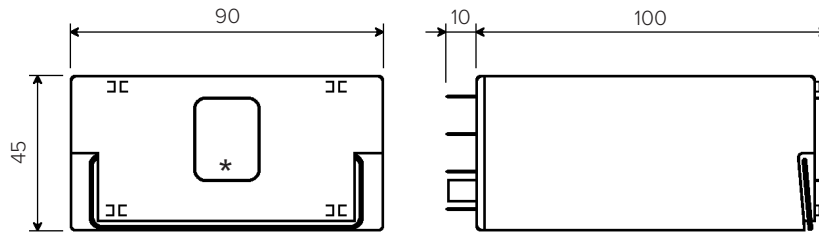

(*) access to the manual operating lever



ELECTRICAL LIFE EXPECTANCY

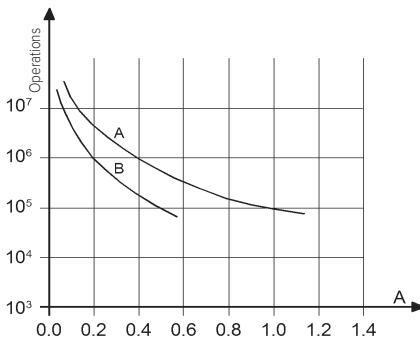

Contact loading: 110Vdc, L/R 40 ms

Curve A: RMM.x6X

Curve B: RMM.x2X

RMM.x2X			
U	I (A)	L/R (ms)	Operations
110Vdc	0.5	40	100,000
110Vdc	0.6	10	300,000
120Vdc	0.7	40	50,000
125Vdc	1.2	0	1,000,000
220Vdc	0.1	40	100,000
220Vdc	0.25	10	100,000
U	I (A)	cosφ	Operations
110Vac	1	1	2,000,000
110Vac	1	0.5	1,500,000
110Vac	5	1	1,000,000
110Vac	5	0.5	500,000
220Vac	0.5	1	2,000,000
220Vac	1	0.5	600,000
220Vac	5	1	650,000
220Vac	5	0.5	600,000

RMM.x6X			
U	I (A)	L/R (ms)	Operations
24Vdc	1	0	7,000,000
24Vdc	1	40	3,000,000
24Vdc	2	40	2,000,000
24Vdc	5	0	3,000,000
24Vdc	5	40	200,000
24Vdc	9	0	800,000
48Vdc	5	20	200,000
110Vdc	0.4	40	1,000,000
110Vdc	1	40	100,000
110Vdc	10	0	100,000
U	I (A)	cosφ	Operations
220Vac	5	0.5	100,000
220Vac	10	1	100,000
230Vac	1	0.7	2,500,000
230Vac	3	0.7	1,200,000

Switching frequency: 1,200 operations/hour



SOCKETS AND RETAINING CLIPS

RETAINING CLIP

Type of installation	Type of outputs	Model	
Wall or DIN rail mounting	Screw	96IP20-I DIN	RMC48
	Spring clamp	PAIR320	
Flush mounting	Double faston (4.8 x 0.8 mm)	ADF4	
	Spring clamp	PRIR320	



INSTALLATION, OPERATION AND MAINTENANCE

Installation

Before installing the relay on a wired socket, disconnect the power supply.

The preferential mounting position is on the wall, with the relay positioned horizontally in the "reading orienting" of marking so that the label is readable in the correct sense.

Spacing: the distance between adjacent relays depends on use' conditions.

If a relay is used in the "less favorable" conditions that occur with "simultaneously":

- Power supply: the maximum allowed, permanently
- Ambient temperature: the maximum allowed, permanently
- Current on the contacts: the maximum allowed, permanently
- Number of contacts used: 100%

It is strongly recommended to space relay at least 5 mm horizontally and 20 mm vertically, to allow for proper upward heat' dissipation and increase the longevity of the component.

Actually, relays could be used in less severe conditions. In this case, the distance between adjacent relays can be reduced or abolished. A correct interpretation of the use' conditions allows the optimization of the available spaces. Contact AMRA for more information.

To increase relay' longevity, we recommend mounting relays intended for "continuous use" (permanent power supply), alternating them with relays intended for less frequent use.

For a safe use, the retaining clip is recommended. For use on rolling stock, relays have been tested to EN 61373 standard equipped with retaining clip(s).

Operation

Before use: if relay is not used, for example after long storage periods, contact resistance may increase due to a natural and slight oxidation or polluting deposits.

In order to restore the optimal conductivity and for standard contacts (**NOT gold plated**) it is recommended to switch several time a load of at least 110Vdc - 100mA or 24Vdc - 500mA. The contacts will be "cleaned" thanks to the electric arc generated during the current interruption and the mechanical self-cleaning action.

The common contact rubs against the fixed poles (NO and NC contacts) both when opening and when closing, which ensures a self-cleaning action.

An increase in contacts' resistance, in most cases, does not represent a problem. Many factors contribute to the correct use of contact and consequently to the relay' long-term reliability:

- **Load:** the current switching generates an electric arc with cleaning effects. For proper electrical cleaning and performance keeping we recommend:
 - o Standard contacts: Minimum current = 20mA
 - o Gold plated contacts: Minimum current = 10mA
- **Operating frequency:** relays are components that can operate with a wide range of switching frequency. High frequency operation also allows a continuous cleaning effect by "sliding" (mechanical cleaning). In case of low frequency operation (for example few time a day), we advise:
 - o Use of contact with currents twice compared to those indicated.
 - o For currents lower than 10mA, use gold plated contacts and connect 2 contacts in parallel, in order to reduce the equivalent contact resistance
- **Pollution:** the presence of pollution can cause impurities on contact surface. Electric charges attract organic molecules and impurities that are deposited on the contact surface. Electrical and mechanical cleaning, respectively, burn and remove such impurities. In pollution presence, the minimum recommended currents must be respected. In extreme cases, provide double the cleaning current.

Condensation is possible inside the relay when energized and the outside ambient temperature is cold; this is quite normal and does not affect the operation of the relay. Plastic materials of relay do not possess hygroscopic properties.

Maintenance

No maintenance is required.

In case of normal relay wear (reaching the end of electrical or mechanical life), the relay cannot be restored and must be replaced.

To check the component, relay removal must be carried out with slight lateral movements. An "up and down" movement can cause terminals damage.

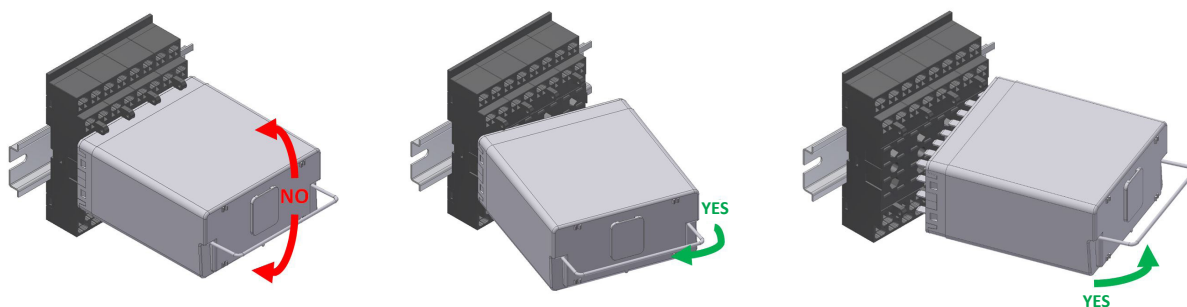

Often the malfunctions are caused by power supply with inverted polarity, by external events or by use with loads exceeding the contact performance.

In case of suspected malfunction, energize relay and observe if mechanical operation of contacts / relay mechanism is performed. Pay attention to the power supply polarity, if relay is equipped with polarized components (example: diode, led).

- In case of expected operation, clean the contacts (see paragraph "OPERATION") and check if the circuit load ranges within the contact performance. If necessary, replace with relays with gold contacts. Note: the electrical continuity of contacts must be checked with adequate current.
- If it does not work, we recommend to use a relay of the same model and configuration.

If an investigation by AMRA is required, pull-out the relay from the socket, don't remove the cap, avoid any other manipulation and contact us. You will be asked for the following data: environmental conditions, power supply, switching frequency, contact load, number of operations performed.

The fault can be described through the "TECHNICAL SUPPORT" section of the website www.amra-chauvin-arnoux.it.

In any case, the relay cannot be repaired by the user.

Storage

Storage conditions must guarantee the environmental conditions (temperature, humidity and pollution) required for the product conservation, in order to avoid deterioration.

The product must be stored in an environment sheltered from atmospheric agents and not polluted, with an ambient temperature between -25 and +85°C with max 75% RH. Humidity can reach peaks of 95%. In any case, there must be no condensation. Before use, please read carefully "OPERATION" section.

RMBX

INSTANTANEOUS BISTABLE (LATCHING) RELAYS WITH 7-8 CHANGE-OVER CONTACTS

APPLICATIONS

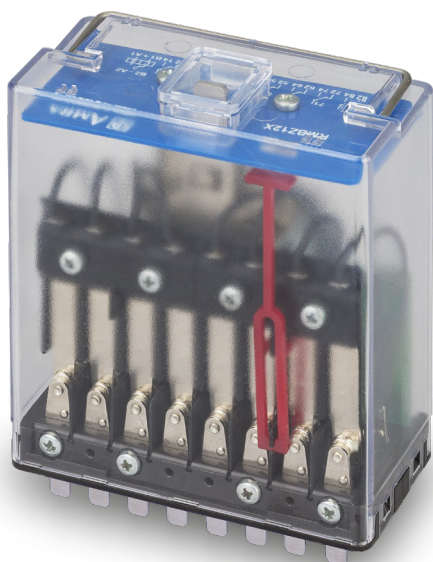

OVERVIEW

- Compact plug-in monostable instantaneous relay
- Compact dimensions than RMB Series
- Solid and rugged construction for intensive duty, IP50 protection
- Self-cleaning knurled contacts, C/O type
- Pulsed or permanent power supply and de-energization system
- High electrical life expectancy and exceptional endurance
- Fitted with mechanical optical contact status indicator as standard
- Wide variety of configurations and customizations
- Retaining clip for secure locking of relay on socket
- Transparent cover, with access for manual operation (standard) and pull-out handle

DESCRIPTION

RMBX relays, with 7 & 8 changeover contacts, are highly reliable products featuring high performance, suitable for applications in very harsh and disturbed environments, such as per electrical transformer stations, rail equipment and rolling stock.

The construction of the relays and careful choice of the materials ensure long life and considerable ruggedness even in harsh operating environments and in the presence of strong temperature fluctuations.

Wide range of coil's nominal voltage are available.

The manufacturing versatility allows to adapt power supply to customer needs.

The IP50 protection allows the relay to be used even in dusty environments, protecting contact's surface against harmful deposits, with great benefit in conducting very low loads.

RMBX relays are equipped with an automatic coil de-energization system, operated mechanically, designed to reduce the power consumption of the device to zero on completion of the cycle.

Contacts are designed to obtain remarkable performances both for high, inductive loads or very low loads. Contact is able to switch from 5mA – 5V.

The knurled surface ensures an excellent self-cleaning effect, lower ohmic resistance thanks to the various points of electrical contact, improving also the electrical life of the component.

Thanks to its exceptional breaking capacity, the relay is suitable for controlling heavy duty loads where safety and continuity of operation are all-important.

Manual operation is foreseen for all models, allowing tests to be conducted in the absence of any power supply.

Available options: flyback coil protection diode and gold plated contacts.

A wide range of sockets allow to find the optimal solutions for any electrical panel's construction need.

As per all AMRA relays, RMBX relays are assembled under controlled manufacturing process in which every step of production is verified by the next step in succession. 100% of relay are tested at the end of production stage.

STANDARD COMPLIANCY

EN 60077	EN 61810-1
EN 61373	EN 61810-7
EN 45545-2	EN 60695-2-10
ASTM E162, E662	EN 60529



MODELS	NUMBER OF CONTACTS	POWER INPUT TO COILS
RMB.x3X	7	Common negative
RMB.x2X ⁽¹⁾	8	Common negative

(1) Model RMBR.x2X suitable for rolling stock applications



FOR PRODUCT CODE CONFIGURATION , SEE THE "ORDERING SCHEME" TABLE



COIL DATA	RMB.x3X, RMB.x2X	RMBR.x2X
Nominal voltages Un	DC: 12-24-48-110-125-132-220 ⁽¹⁾ - AC: 12-24-48-110-125-230-380-440 ⁽¹⁻²⁾	DC: 24 - 36 - 72 - 96 - 110 ⁽³⁾
Consumption at Un (DC/AC) ⁽²⁾	RMB.x3X: 15W / 15VA - RMB.x2X: 19W / 19VA	19W / 19VA
Operating range	DC: 80÷120% Un - AC: 85÷110% Un	DC: 70÷125 % Un
Type of duty	Continuous	

Minimum control pulse: 50ms.

(1) Other values on request.

(2) Latch and unlatch. Power consumption is zero on completion of the operating cycle, as the coil de-energizes automatically.

(3) Suitable for rolling stock applications. Operating range in compliance with EN 60077 standard.



CONTACT DATA	RMB.x3X	RMBR.x2X
Number and type	7 SPDT, form C	8 SPDT, form C
Current	10A 20A for 1min - 40A for 1s 150A for 10ms	
Nominal ⁽¹⁾		
Maximum peak ⁽²⁾		
Maximum pulse ⁽²⁾		
Example of electrical life expectancy ⁽³⁾	0.7A - 132Vdc - L/R 40ms - 10 ⁵ operations - 600 operations/hour	
Minimum load ⁽⁴⁾	200mW (10V, 10mA)	
Standard contacts	50mW (5V, 5mA)	
Gold-plated contacts ⁽⁵⁾		
Maximum breaking voltage	350 VDC / 440 VAC	
Contact material	AgCdO	
Operating time at Un (ms) ⁽⁶⁾	DC - AC	DC - AC
Pick-up (NC contact opening)	≤ 10 - ≤ 25	≤ 25 - ≤ 25
Pick-up (NO contact closing)	≤ 25 - ≤ 40	≤ 28 - ≤ 35
Drop-out (NO contact opening)	≤ 10 - ≤ 25	≤ 10 - ≤ 20
Drop-out (NC contact closing):	≤ 45 - ≤ 55	≤ 43 - ≤ 53

(1) On all contacts simultaneously, reduction of 30%.

(2) Maximum peak and pulse currents are those currents that can be handled, for a specified time, by the contact. They do not refer to steady or interrupted currents.

(3) For other examples, see electrical life expectancy curves.

(4) Values referred to a new product, measured in laboratory. The ability to maintain this performance over the time depends on the environmental conditions and the contact' frequency use. The use of gold plated contacts is recommended in the case of very low loads.

(5) A gold contact, if subjected to high loads, degrades superficially. In this case, the characteristics of the standard contact must be considered. This does not affect the operation of the relay.

(6) Unless specified otherwise, the operating time signifies until stabilization of the contact (including bounces).



INSULATION

Insulation resistance (at 500VCD) between electrically independent circuits and between these circuits and ground between open contact parts	> 10,000 MΩ > 10,000 MΩ
Withstand voltage at industrial frequency between electrically independent circuits and between these circuits and ground between open contact parts between adjacent contacts	2 kV (1 min.) - 2.2kV (1 s) 2 kV (1 min.) - 2.2kV (1 s) 2 kV (1 min.) - 2.2kV (1 s)
Impulse withstand voltage (1.2/50µs - 0.5J) between electrically independent circuits and between these circuits and ground between open contact parts	5 kV 4 kV

MECHANICAL SPECIFICATIONS

Mechanical life expectancy	10x10 ⁶ operations
Maximum mechanical switching rate	900 operations/hour
Degree of protection	IP50 fitted to socket
Dimensions (mm) ⁽¹⁾	45x90x100 ⁽¹⁾
Weight (g)	RMB.x3X: 400 RMB.x2X: 410

(1) Output terminals excluded.

ENVIRONMENTAL SPECIFICATIONS

Standard operating temperature	standard	-25 to +55°C
Version for railways, rolling stock (RMBR)		-25 to +70°C (+85°C for 10 min) -40°C as option
Storage and shipping temperature		-25 to +85°C
Relative humidity		Standard: 75% RH - Tropicalized: 95% RH
Fire behaviour		V0

STANDARDS AND REFERENCE VALUES

EN 61810-1, EN 61810-2, EN 61810-7	All-or-nothing relays
EN 60695-2-10	Fire behaviour
EN 60529	Degree of protection provided by enclosures

Unless otherwise specified, products are designed and manufactured to the requirements of the European and International standards indicated above.

In accordance with EN 61810-1, all items of technical data are referred to ambient temperature 23 °C, atmospheric pressure 96kPa and 50% humidity.

Tolerance for coil resistance, nominal electrical input and nominal power is ±7%.

RAILWAYS, ROLLING STOCK - STANDARDS APPLICABLE TO RMBR MODEL

EN 60077	Electric equipment for rolling stock - General service conditions and general rules
EN 61373 ⁽¹⁾	Shock and vibration tests, Cat 1, Class B
EN 45545-2	Fire behaviour, Cat E10, requirement R26, V0
ASTM E162, E662	Fire behaviour

(1) Opening of NC contacts allowed only at de-energized relay t<3ms.

CONFIGURATIONS - OPTIONS

TROPICALIZATION	Surface treatment of coil with protective coating for use in conditions of RH 95%. This treatment serves to give the coil added protection against corrosion that could occur as a result of moisture reacting with certain chemical agents such as those found in acid or saline atmospheres.
GOLD PLATING	Surface treatment of contacts, blades and output terminals with gold, thickness ≥ 2μ. This treatment ensures long-term capacity of the contact to conduct low levels of current, even in adverse ambient conditions.
FLYBACK DIODE	Component connected in parallel with the coil designed to suppress overvoltages generated by the coil when de-energized.
LOW TEMPERATURE	Minimum operating temperature -40°C, only for rolling stock version (option "L")

ORDERING SCHEME

PRODUCT CODE	APPLICATION ⁽¹⁾	CONFIGURATION A	CONFIGURATION B	TYPE OF POWER SUPPLY	NOMINAL VOLTAGE (V) ⁽²⁾	FINISH ⁽³⁾	KEYING POSITION CODE ⁽⁴⁾
RMB	E: Energy F: Railway Fixed Equipment R: Railway Rolling stock	1: Standard 3: Diode // 4: Gold plating 6: Gold plating + Diode //	2X: 8 SPDT contacts 3X: 7 SPDT contacts	C: Vdc A: Vac 50 Hz H: Vac 60 Hz	012 - 024 - 036 048 - 072 - 096 110 - 125 - 132 220 - 230 - 380 440	T: Tropicalized coil L: Low temperature	XX
Example	RMB	E	4	3X	C	110	
	RMBE43X-C110 = ENERGY series relay, with 7 SPDT gold-plated contacts and 110Vac coil.						
	RMB	R	1	2X	C	072	T
RMBR12X-C072T = RAILWAY, rolling stock series, relay with 8 SPDT contacts and 72Vdc tropicalized coil							

1. **ENERGY:** all applications except for railway.

RAILWAYS, FIXED EQUIPMENT: application on fixed power systems and electrical railway traction. For list of RFI compliant and type-approved products, consult dedicated catalogue "RAILWAY SERIES – RFI APPROVED".

RAILWAYS, ROLLING STOCK: Application on board rolling stock. Electrical characteristics according to EN60077.

2. Other values on request. Voltages 380V and 440V available as Vac only.

3. Optional value.

4. Optional value. The positive mechanical keying is applied according to the manufacturer's model.



WIRING DIAGRAM

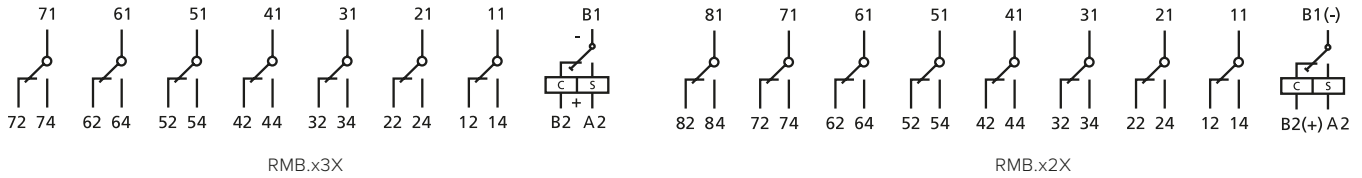

DIMENSIONS

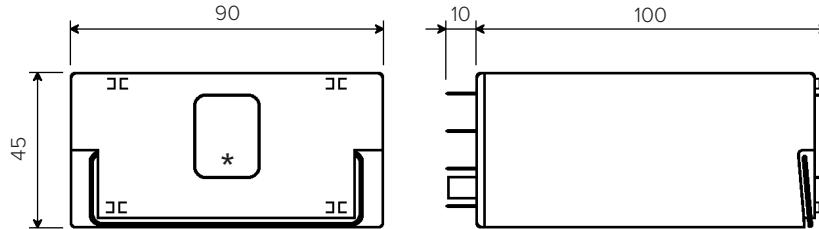

(*) access to the manual operating lever



ELECTRICAL LIFE EXPECTANCY

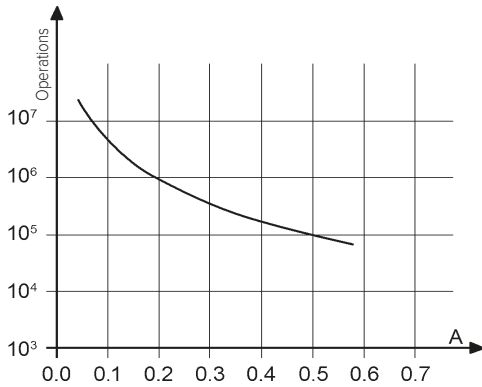

Contact loading: 110Vdc, L/R 40 ms

Switching frequency: 1,200 operations/hour

U	I (A)	L/R (ms)	Operations
110Vdc	0.5	40	150,000
110Vdc	0.6	10	300,000
132Vdc	0.7	40	100,000
125Vdc	1.2	0	1,000,000
220Vdc	0.1	40	100,000
220Vdc	0.25	10	100,000
U	I (A)	cosφ	Operations
110Vac	1	1	2,000,000
110Vac	1	0.5	1,500,000
110Vac	5	1	1,000,000
110Vac	5	0.5	500,000
220Vac	0.5	1	2,000,000
220Vac	1	0.5	600,000
220Vac	5	1	650,000
220Vac	5	0.5	600,000



SOCKETS AND RETAINING CLIPS

RETAINING CLIP

Type of installation	Type of outputs	Model	
Wall or DIN rail mounting	Screw	96IP20-I DIN	RMC48
	Spring clamp	PAIR320	
Flush mounting	Double faston (4.8 x 0.8 mm)	ADF4	
	Spring clamp	PRIR320	



INSTALLATION, OPERATION AND MAINTENANCE

Installation

Before installing the relay on a wired socket, disconnect the power supply.

The preferential mounting position is on the wall, with the relay positioned horizontally in the "reading orienting" of marking.

Spacing: the distance between adjacent relays depends on use' conditions.

For a safe use, the retaining clip is recommended. For use on rolling stock, relays have been tested to EN 61373 standard equipped with retaining clip(s).

Operation

Before use: if relay is not used, for example after long storage periods, contact resistance may increase due to a natural and slight oxidation or polluting deposits.

In order to restore the optimal conductivity and for standard contacts (**NOT gold plated**) it is recommended to switch several time a load of at least 110Vdc - 100mA or 24Vdc - 500mA. The contacts will be "cleaned" thanks to the electric arc generated during the current interruption and the mechanical self-cleaning action.

The common contact rubs against the fixed poles (NO and NC contacts) both when opening and when closing, which ensures a self-cleaning action.

An increase in contacts' resistance, in most cases, does not represent a problem. Many factors contribute to the correct use of contact and consequently to the relay' long-term reliability:

- **Load:** the current switching generates an electric arc with cleaning effects. For proper electrical cleaning and performance keeping we recommend:
 - o Standard contacts: Minimum current = 20mA
 - o Gold plated contacts: Minimum current = 10mA
- **Operating frequency:** relays are components that can operate with a wide range of switching frequency. High frequency operation also allows a continuous cleaning effect by "sliding" (mechanical cleaning). In case of low frequency operation (for example few time a day), we advise:
 - o Use of contact with currents twice compared to those indicated.
 - o For currents lower than 10mA, use gold plated contacts and connect 2 contacts in parallel, in order to reduce the equivalent contact resistance
- **Pollution:** the presence of pollution can cause impurities on contact surface. Electric charges attract organic molecules and impurities that are deposited on the contact surface. Electrical and mechanical cleaning, respectively, burn and remove such impurities. In pollution presence, the minimum recommended currents must be respected. In extreme cases, provide double the cleaning current.

Condensation is possible inside the relay when energized and the outside ambient temperature is cold; this is quite normal and does not affect the operation of the relay. Plastic materials of relay do not possess hygroscopic properties.

Maintenance

No maintenance is required.

In case of normal relay wear (reaching the end of electrical or mechanical life), the relay cannot be restored and must be replaced.

To check the component, relay removal must be carried out with slight lateral movements. An "up and down" movement can cause terminals damage.

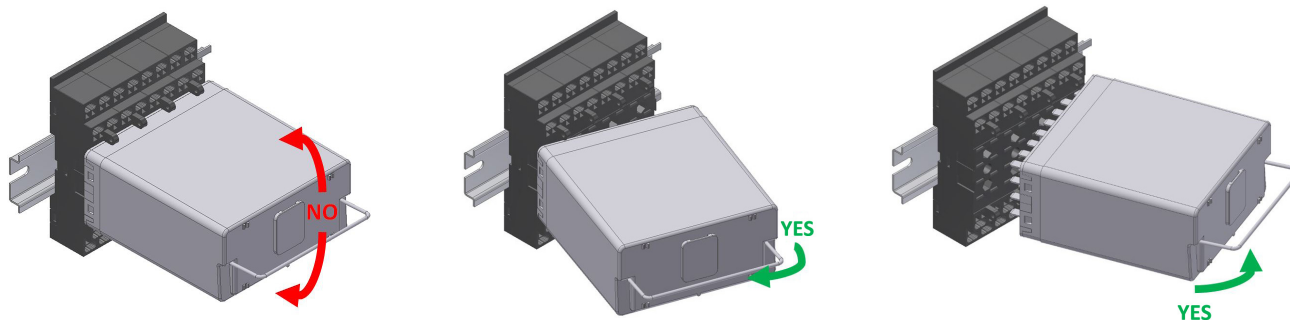

Often the malfunctions are caused by power supply with inverted polarity, by external events or by use with loads exceeding the contact performance.

In case of suspected malfunction, energize relay and observe if mechanical operation of contacts / relay mechanism is performed. Pay attention to the power supply polarity, if relay is equipped with polarized components (example: diode, led).

- In case of expected operation, clean the contacts (see paragraph "OPERATION") and check if the circuit load ranges within the contact performance. If necessary, replace with relays with gold contacts. Note: the electrical continuity of contacts must be checked with adequate current.
- If it does not work, we recommend to use a relay of the same model and configuration.

If an investigation by AMRA is required, pull-out the relay from the socket, don't remove the cap, avoid any other manipulation and contact us. You will be asked for the following data: environmental conditions, power supply, switching frequency, contact load, number of operations performed.

The fault can be described through the "TECHNICAL SUPPORT" section of the website www.amra-chauvin-arnoux.it.

In any case, the relay cannot be repaired by the user.

Storage

Storage conditions must guarantee the environmental conditions (temperature, humidity and pollution) required for the product conservation, in order to avoid deterioration.

The product must be stored in an environment sheltered from atmospheric agents and not polluted, with an ambient temperature between -25 and +85°C with max 75% RH. Humidity can reach peaks of 95%. In any case, there must be no condensation. Before use, please read carefully "OPERATION" section.

TMM

SERIES

MULTIFUNCTION MULTISCALE TIMER
RELAY 4 CONTACTS

APPLICATIONS

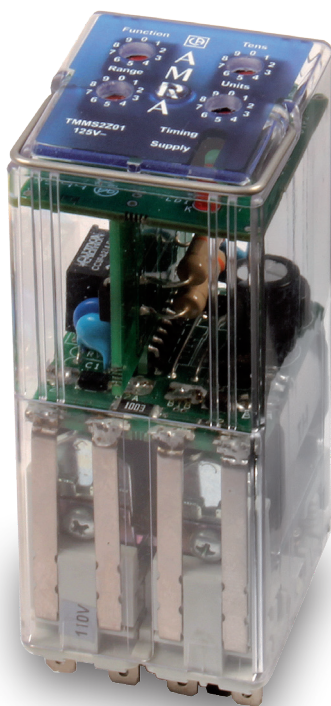

OVERVIEW

- Plug-in relays with time delay, multifunction
- 10 different time delay functions
- 4 time delay contacts or 2 time delay contacts + 2 instantaneous contacts
- Wide time setting range from 0.1s to 99 hours, extreme accuracy across the adjustment range
- High electromagnetic interference immunity
- Solid and rugged construction for heavy or **intensive duties**, considerable long-life
- Independent and self-cleaning contacts
- Magnetic **arc blow-out** standard
- Separate arc breaking chambers
- Excellent **shock and vibration resistance**
- Wide range of sockets
- Wide variety of configurations and customizations
- Retaining clip for secure locking of relay on socket
- Transparent cover, pull-out handle
- Positive **mechanical keying** for relay and socket

DESCRIPTION

The TMM series is a range of **MULTIFUNCTION** relays with electronic time delay, consisting of 2 models with 4 change-over contacts, rated 10 A (nominal). They are obtained by assembling the electromechanical units of the POKS series with a digital electronic circuit.

The electromechanical part features the reliability and ruggedness of relays belonging to the POKS series, while the electronics offers high reliability thanks to the use of a circuit requiring few components and to the careful choice of professional products.

A single TMM series relay offers 10 different timer functions, freely programmable by the user; these include, by way of example, time delay on pick-up or on drop-out, flasher, one-shot, etc.

The switching time can be selected within a wide range extending from 0.1 second to 99 hours, with extreme accuracy guaranteed across the full scale of adjustment. This is made possible by providing the relay with 10 intermediate scales.

The timer function, the scale and the switching time are adjustable by means of 4 rotary switches, each having 10 positions, located on the front of the relay.

The electronic circuit is immune to high electromagnetic interference, typical of high voltage electricity distribution stations. The construction of the relays and careful choice of the materials are such that they ensure long life and considerable ruggedness even in harsh operating environments and in the presence of strong temperature fluctuations.

Excellent electrical and mechanical performance levels allow the product to be used in the most demanding of sectors such as, for example, rail transport, control and signalling functions in electricity generating stations, electrical transformer stations, or in industries with continuous production processes (chemical and petroleum industries, rolling mills, cement factories, etc.). Above all, the excellent ability to withstand shock and vibration allow their use on rolling stock.

STANDARD COMPLIANCE

EN 61810-1	EN 60077
EN 61810-2	EN 50155
EN 61810-7	EN 60695-2-10
EN 61373	EN 61000
EN 45545-2	EN 60529
ASTM E162, E662	

MODELS	NOMINAL CURRENT	NUMBER OF CONTACTS		ROLLING STOCK APPLICATION
		Time-delayed	Instantaneous	
TMM2	10 A	2	2	•
TMM4	10 A	4	-	•

FOR PRODUCT CODE CONFIGURATION, SEE THE "ORDERING SCHEME" TABLE

COIL DATA	
Nominal voltages Un ⁽¹⁾	DC: 12-24-36-48-72-110-125-132-144-220 AC: 12-24-48-110-127-220-230
Max. consumption at Un	TMM2: 5.5 W / 7.5VA TMM4: 4.5 W / 6.5 VA
Operating range ⁽¹⁾	80...115% Un
Rolling stock version ⁽²⁾⁽³⁾	DC: 70...125% Un
Type of duty	Continuous
Drop-out voltage ⁽⁴⁾	> 15% Un

(1) Other values on request.

(2) See "Ordering scheme" table for order code.

(3) For operating ranges different to that specified by EN60077, refer to table "Rolling stock versions - Special Ranges".

(4) Limit value for supply voltage, expressed as % of the nominal value, beneath which the relay is certainly de-energized.

CONTACT DATA	TMM2	TMM4
Number and type	2 timed + 2 instantaneous SPDT, form C	4 timed, SPDT, form C
Current		
Nominal ⁽¹⁾	10 A	
Maximum peak (1 s) ⁽²⁾	20 A (1min) / 40 A (500ms)	
Maximum pulse (10 ms) ⁽²⁾	150 A	
Example of electrical life expectancy ⁽³⁾	0.7 A – 132 Vdc – L/R 40 ms : 10 ⁵ operations	
1,800 operations/h	1 A – 110 Vdc – L/R 0 ms : 10 ⁵ operations	
Making capacity	30 A (for 200 ms) – 110Vdc – L/R 0 ms : 2,000 operations	
Minimum load ⁽⁴⁾		
Standard contacts	500 mW (20V, 20 mA)	
Gold-plated contact P4GEO ⁽⁵⁾	100 mW (10V, 5 mA)	
Gold-plated contact P8 ⁽⁵⁾	50 mW (5V, 5 mA)	
Maximum breaking voltage	250 Vdc / 350 Vac	
Contact material	AgCu	
Operating time at Un (ms) ⁽⁶⁾⁽⁷⁾	DC ⁽⁸⁾ – AC	
Pick-up (NO contact closing)	≤ 20 - ≤ 20	
Drop-out (NC contact closing)	≤ 15 - ≤ 20	

(1) On all contacts simultaneously, reduction of 30%.

(2) The max. peak and pulse currents are those currents that can be handled, for a specified time, by the contact. They do not refer to steady or interrupted currents.

(3) For other values, see electrical life expectancy curves.

(4) Values referred to a new product, measured in laboratory. The ability to maintain this performance over the time depends on the environmental conditions and the contact' frequency use. The use of gold plated contacts is recommended in the case of very low loads.

(5) Specifications of contacts on new relay

a. Plating material: **P4 GEO**: gold-nickel alloy (>6μ) **P8**: gold-cobalt alloy (>5μ), knurled contact

b. When the gold-plated contact is subject to heavy loads, it will be degraded on the surface. In such case, the characteristics of the standard contact should be taken into consideration. This does not impair relay operation.

(6) Times for the instantaneous component of the relay (TMM2 model).

(7) Unless specified otherwise, the operating time signifies until stabilization of the contact (including bounces). It should be added to the preset delay time.

(8) Addition of a flyback diode connected in parallel with the coil (DC version only) causes an increase in operating time when the relay drops out.

INSULATION



Insulation resistance (at 500Vdc)		
between electrically independent circuits and between these circuits and ground		> 1,000 MΩ
between open contact parts		> 1,000 MΩ
Withstand voltage at industrial frequency		
between electrically independent circuits and between these circuits and ground		2 kV (1 min) - 2.2 kV (1 s)
between open contact parts		1 kV (1 min) - 1.1 kV (1 s)
between adjacent contacts		2.5 kV (1 min) - 3 kV (1 s)
Withstand voltage at industrial frequency (1.2/50μs – 0.5J)		
between electrically independent circuits and between these circuits and ground		5 kV
between open contact parts		3 kV

MECHANICAL SPECIFICATIONS



	Mechanical life	10 x 10 ⁶ operations
Maximum switching rate	Mechanical life expectancy	3,600 operations / hour
	Degree of protection (with relay mounted)	IP40
	Dimensions (mm) ⁽¹⁾	40 x 50 x 97
	Weight (g)	~ 220

1. Output terminals excluded.

ENVIRONMENTAL SPECIFICATIONS



Operating temperature	Standard	-25° to +55°C
	Version for railway, rolling stock	-25° to +70°C
Storage and shipping temperature		-40° to +70°C
Relative humidity	Standard: 75% RH	Tropicalized: 95% RH
Resistance to vibrations		5g - 10 to 55 Hz - 1 min
Resistance to shock		20g – 11 ms
Fire behaviour		V0

STANDARDS AND REFERENCE VALUES



EN 61810-1, EN 61810-2, EN 61810-7	Electromechanical elementary relays
EN 61812-1	Timer relays
EN 60695-2-10	Fire behaviour
EN 61000	Electromagnetic compatibility
EN 60529	Degree of protection provided by enclosures

Unless otherwise specified, the products are designed and manufactured according to the requirements of the above-mentioned European and International standards.

In accordance with EN 61810-1, all items of technical data are referred to ambient temperature 23 °C, atmospheric pressure 96kPa and 50% humidity.

Tolerance for coil resistance, nominal electrical input and nominal power is ±7%.

RAILWAYS, ROLLING STOCK - STANDARDS



EN 60077	Electric equipment for rolling stock. General service conditions and general rules
EN 50155	Electronic equipment used on rolling stock
EN 61373	Shock and vibration tests, Cat 1 Class B
EN 45545-2	Fire behavior, Cat E10, Requirement R26, V0
ASTM E162, E662	Fire behaviour

RAILWAYS, ROLLING STOCK – SPECIAL OPERATING RANGES⁽¹⁾



Nominal voltage	Minimum pick-up voltage	Maximum operating voltage	Order symbol ⁽¹⁾
24 Vdc	16.8	32	Z01
72 Vdc	55	104	Z01
110 Vdc	77	144	Z01

(1) To request the special range, indicate the "Z0x" symbol in the "Keying position" field in the "Ordering scheme" table.

The special range may be subject to operating specifications different from standard specifications. Please contact us for further information.



CONFIGURATIONS - OPTIONS

P2	Tropicalization of the coil with epoxy resin for use with 95% RH (@ T 50 °C). This treatment also protects the coil against corrosion which could occur by combination of the humidity with certain chemical agents, such as those found in acid atmospheres (typical of geothermal power stations) or saline atmospheres
P4GEO	Gold plating of contacts with gold-nickel alloy, thickness $\geq 6\mu$. This treatment ensures long-term capacity of the contact to conduct lower currents in harsh ambient conditions such as acid atmospheres (typical of geothermal power stations) or saline atmospheres
P5GEO	P4GEO gold-plating of contacts + P2 coil tropicalization
P6GEO	P4GEO type gold-plating, but applied to contacts, contact terminal and output terminals + P2 coil tropicalization
P7	AgCdO (silver cadmium oxide) contacts.
P8	Gold plating of contacts with gold-cobalt alloy, thickness $\geq 5\mu$, knurled fixed contact. This finish allows further improvement of the gold-plated contact performance compared to the treatment P4GEO.
FLYBACK DIODE	Polarized component connected in parallel with the coil (type 1N4007 or BYW56 for rolling stock version) designed to suppress overvoltages generated by the coil when de-energized.
TRANSIL	Non-polarized component connected in parallel with the coil. Behaviour is similar to that of a varistor, with faster operating times.



ORDERING SCHEME

PRODUCT CODE	APPLICATION ⁽¹⁾	CONFIGURATION A	CONFIGURATION B	TYPE OF POWER SUPPLY	NOMINAL VOLTAGE (V) ⁽²⁾	KEYING POSITION ⁽³⁾
TMM2 TMM4	E: Energy F: Railway Fixed Equipment R: Railway Rolling Stock	1: Standard 2: Diode // 3: Varistor 7: Transil	0: Standard 2: P2 4: P4 GEO 5: P5 GEO 6: P6 GEO 7: P7 8: P8	C: Vdc A: Vac 50 Hz	012 - 024 - 036 048 - 072 - 100 110 - 125 - 127 132 - 144 - 220 230	XXX

Example	TMM2	E	1	8	C	024	
	TMM2E18-C024 - TMM2 relay, ENERGY series, nominal voltage 24 Vdc, with P8 finish (gold-plated contacts)						
	TMM4	R	1	0	C	110	
	TMM4R10-C110 - TMM4 relay, ROLLING STOCK series, nominal voltage 110 Vdc						

(1) **ENERGY:** all applications except for railway. Suitable on energy production, transport and distribution plants, railways fixed equipment, petrochemical and heavy industry.

RAILWAYS, FIXED EQUIPMENT: application on fixed power systems and electrical railway traction.

Construction according to RFI (FS Group) specification no. RFI DPRIM STF IFS TE 143 A, if applicable.

For list of RFI compliant and type-approved products, consult dedicated catalogue "RAILWAY SERIES – RFI APPROVED".

RAILWAYS, ROLLING STOCK: Application on board rolling stock (rail-tram-trolley vehicles). Electrical specifications according to EN60077.

Also available is the **STATIONS** series, with ENEL approved material meeting LV15/LV16 specifications.

For list of ENEL compliant and type-approved products, consult dedicated catalogue "STATIONS SERIES – LV15-LV16-LV20".

(2) Other values on request.

(3) Optional value. The positive mechanical keying is applied according to the manufacturer's model.

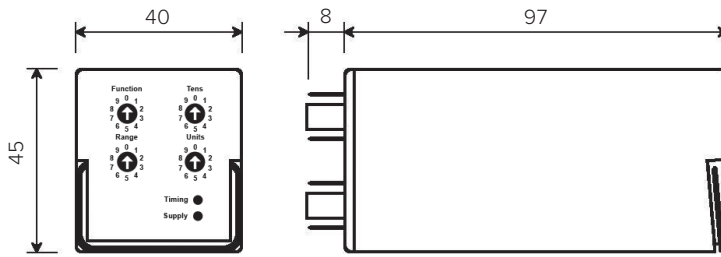

Timing = Green Led: time delay activated
 Supply = Red Led: auxiliary power on

WIRING DIAGRAM

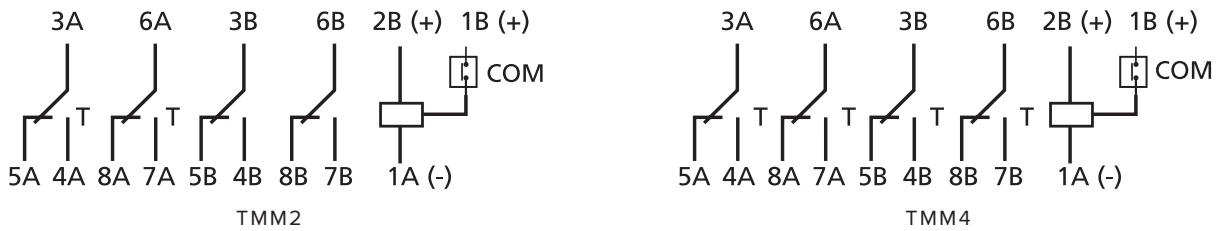

T= time delay contacts

Terminals 2B and 1A are allocated to the auxiliary power supply.

Terminal 1B is allocated to CONTROL. The negative of the control circuit is common with that of the auxiliary power supply.

Certain functions require an auxiliary power supply to guarantee operation of the time delay (terminal 2B).

TIME DELAY – SWITCHING TIME SETTING



Controls setting function, range and time	4 rotary switches with 10 positions (0...9)	
Time setting range	100 ms...99 h	
Intermediate scales	10, from 9.9 seconds to 99 hours	
Resolution of switching time setting	1% of intermediate scale	
Accuracy, time delay (0.8...1.1 Un, t=20°C)	DC : ± 1% of selected time or ± 5 ms (1) AC : ± 1% of selected time; 0,1s...10s: ± 2% ± 20ms	
Accuracy, repeatability	DC : ± 0.5%	AC : ± 0.5% + 20 ms
Reset	< 200ms	during time delay interval < 400ms

(1) Whichever of the two values is higher.

The function and switching time are adjustable by means of 4 rotary-switch located on the front of the relay, each having 10 positions, with which the user can select time delay settings between 100 ms and 99 hours.

The position of the arrow point on each rotary switch indicates the number selected.

Adjustments are made by discrete steps, which means that no intermediate settings are possible.

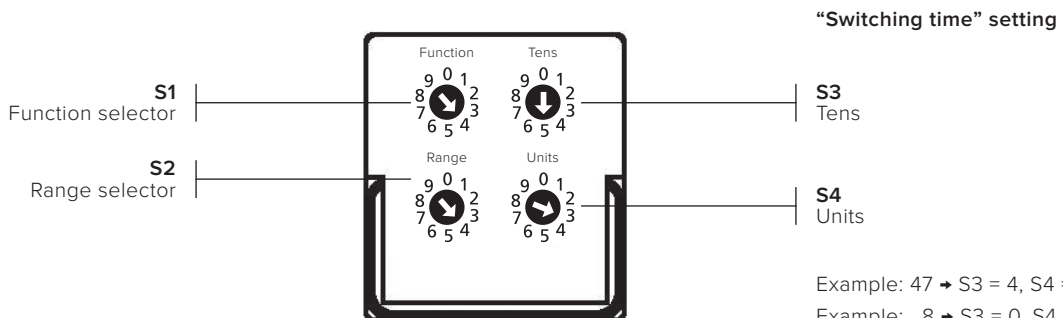

Example: 47 → S3 = 4, S4 = 7
 Example: 8 → S3 = 0, S4 = 8

ADJUSTMENT OF SWITCHING TIME (EXCEPT FOR FUNCTION F5)

To adjust the switching time, the first step is to adjust the intermediate scale T(s), by selecting one of the 10 available scales using the S2 rotary switch. The values available are given in table 1.

Scale	Minimum value	Maximum value	Step
0	0.1s	9.9s	100ms
1	1s	99s	1s
2	3s	297s	3s
3	5s	495s	5s
4	10s	990s	10s

Scale	Minimum value	Maximum value	Step
5	1min	99min	1min
6	3min	297min	3min
7	5min	495min	5min
8	10min	990min	10min
9	1h	99h	1h

Table 1 – Available scales

Next, the switching time is adjusted by means of rotary-switch selectors S3 and S4.

The combination of these two 10-position controls, located on the right, allows the selection of a number between 1 and 99.

The number selected with the “Tens” arrow combined with the number selected with the “Units” arrow represents the multiplier of the step selected via the “Range” control. The resulting value gives the time used by the relay in operation.



Range

Example of setting “4”.
Minimum value 10s, maximum value 990s.
The step setting is 10s.



Tens

Units

Example of setting “53”.
The scale selected previously is number 4, which has an adjustment step of 10s.
The time used by the relay in operation will be:
 $53 \times 10s = 530$ seconds



Setting's changes have to be operate with relays switched off.
Setting's changes with energized relay have no effect.

ADJUSTMENT OF SWITCHING TIME FOR FUNCTION F5 – ASYMMETRIC FLASH

Function F5 pilots an asymmetric flash. The “ON” time and the “OFF” time are adjustable independently

“ON” time (t) → selector S3

“OFF” time (T) → selector S4

In this instance, selector S3 and selector S4 are both calibrated in UNITS. Position “0” assumes the value of 10 integers.

Once the scale has been set by means of selector S2, selectors S3 and S4 are used to set the number that will provide the multiplier for the step of the selected scale.

Example: S2 = 1 → unit of time : seconds

S3 = 3 → t = 3 seconds

S4 = 0 → T = 10 seconds

SELECTING THE FUNCTION

The function is selected by positioning the arrow of selector S1 so that the point is aligned with the number of the required function.

FUNCTION	DESCRIPTION
F0	Time delay on pick-up.
F1	Time delay on drop-out. Instantaneous contacts follow the status of the auxiliary power supply.
F2	Time delay on drop-out, instantaneous contacts on "CONTROL". Instantaneous contacts follow the status of the control signal.
F3	One-shot function.
F4	Flasher, symmetrical. The "ON" time and the "OFF" time are the same.
F5	Flasher, asymmetrical. The "ON" time and the "OFF" time are different, and adjustable independently.
F6	One-shot function on "CONTROL". The timing cycle starts on activation of the control signal.
F7	One-shot function with fixed pulse (3s), delayed at pick-up. Pulse delay adjustable.
F8	One-shot function, on "CONTROL", with fixed pulse (3s), delayed at pick-up. The timing cycle starts on activation of the control signal. Pulse delay adjustable.
F9	Step function.

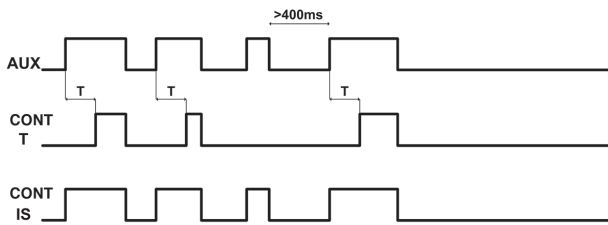

F0 – Time delay on pick-up.

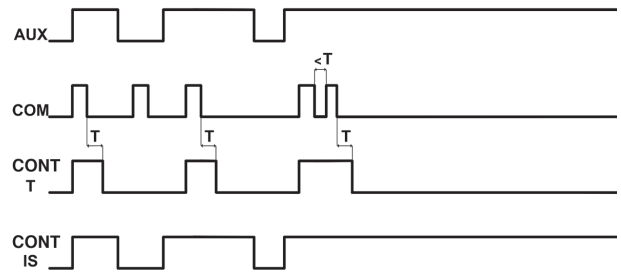

F1 – Time delay on drop-out, instantaneous contacts follow the status of the auxiliary power supply.

The instantaneous contacts follow the status of the auxiliary power supply (2B terminal).

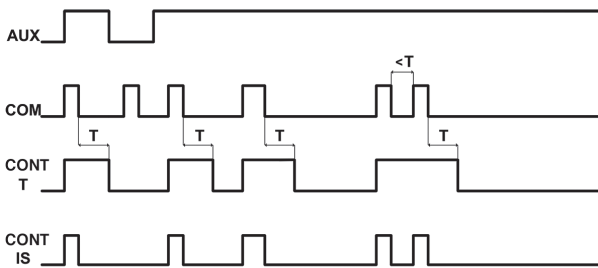

F2– Time delay on drop-out.

The instantaneous contacts follow the status of the control signal ("COM", 1B terminal).

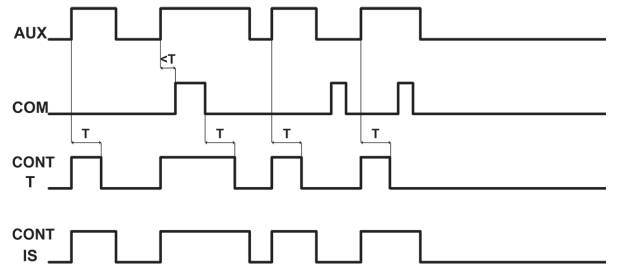

F3 – One-shot function.

The control signal ("COM", 1B terminal) resets the time "t", on drop-out.

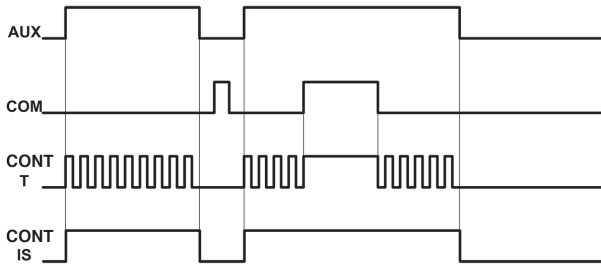

F4 – Flasher, symmetrical.

The control signal ("COM", 1B terminal) stops the flash.

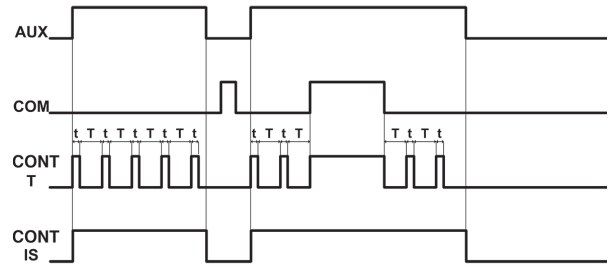

F5 – Flasher, asymmetrical.

The control signal ("COM", 1B terminal) stops the flash t and T are adjustable using the same unit of time.
 Example: S2 = 1 → unit of time: seconds
 S3 = 3 → t = 3 seconds
 S4 = 0 → T = 10 seconds

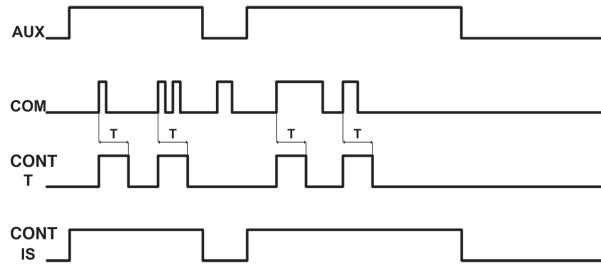

F6 – One-shot function on "CONTROL" (COM).

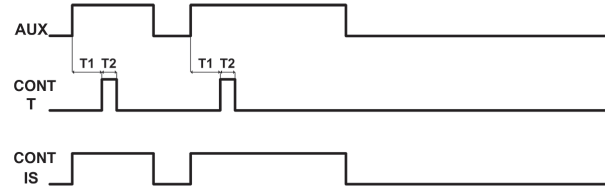

F7 – One-shot function with fixed pulse (3s), delayed at pick-up.

T1: adjustable by way of selector S3 / S4
 T2 : fixed, 3 seconds

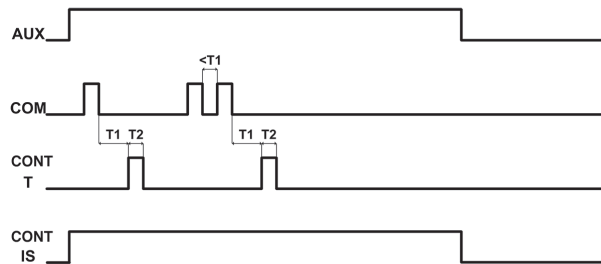

F8 – One-shot function, on "CONTROL", with fixed pulse (3s), delayed at pick-up.

T1: adjustable by way of selector S3 / S4
 T2 : fixed, 3 seconds
 Control signal ("COM", 1B terminal) starts time delay T1
 Control signal ("COM", 1B terminal) restarts the time, if this appears during the time delay.

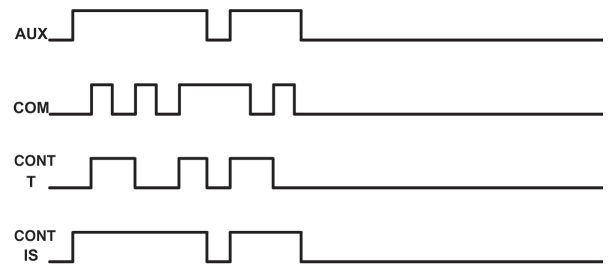

F9 – Step function

The S3 and S4 switches have no effect on the relay operation.

Applicable note for all operations diagrams:

- AUX: 2B - 1A terminals
- COM: 1B terminal
- CONT T: timed contacts
- CONT I: instantaneous contacts

See "Wiring diagram" to identify the instantaneous and timed contacts terminals'.

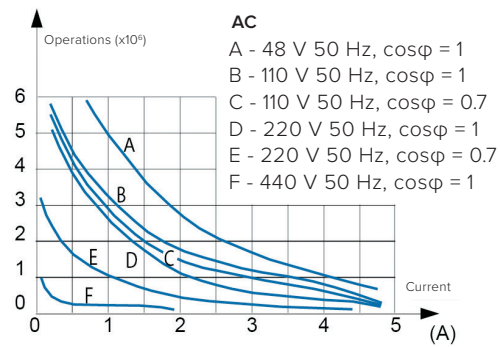
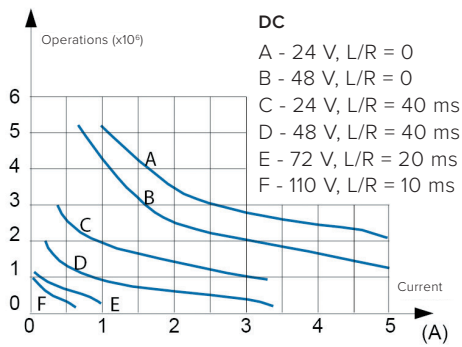

Some examples of electrical life expectancy

- 12Vdc - 10 A - Resistive : 10⁶ operations
- 48Vdc - 5 A - L/R 10 ms : 5 x 10⁵ operations
- 80Vdc - 5 A - Resistive : 5 x 10⁵ operations
- 110Vdc - 0.5 A - L/R 10 ms : 5 x 10⁵ operations
- 110Vdc - 1 A - L/R 0 ms : 10⁵ operations

- 132 Vdc - 0.7 A - 132 Vdc - L/R 40 ms : 10⁵ operations
- 220Vdc - 0.2 A - L/R 10 ms : 10⁵ operations
- 110Vac - 5 A - Cosφ 0.7 : 5 x 10⁵ operations
- 220Vac - 3 A - Cosφ 0.7 : 5 x 10⁵ operations
- 440Vac - 0,2 A - Resistive : 5 x 10⁵ operations

(1) Switching frequency 1,200 operations/hour, cycle 50%.

SOCKETS AND RETAINING CLIPS



Number of terminals (standard dimensions 5x0.8 mm)	16	Retaining clip
For wall or rail mounting		
Spring clamp, wall or DIN H35 rail mounting	PAIR160	RT48
Screw, wall or DIN H35 rail mounting	48BIP20-I DIN	RT48
Screw, wall mounting	48BL	RT48
For flush mounting		
Spring clamp	PRIR160	RT48
Double faston (4.8 x 0.8 mm)	ADF2	RT48
Screw	43IL	RT48
For mounting on PCB		
	65	

(1) Insert the clip before fastening the socket on the panel.
For more details, see specifications of mounting accessories.

INSTALLATION, OPERATION AND MAINTENANCE



Installation

Before installing the relay on a wired socket, disconnect the power supply.

The preferential mounting position is on the wall, with the relay positioned horizontally in the “reading orienting” of marking so that the label is readable in the correct sense.

Spacing: the distance between adjacent relays depends on use' conditions.

If a relay is used in the "less favorable" conditions that occur with "simultaneously":

- Power supply: the maximum allowed, permanently
- Ambient temperature: the maximum allowed, permanently
- Current on the contacts: the maximum allowed, permanently
- Number of contacts used: 100%

it is strongly recommended to space relay at least 5 mm horizontally and 20 mm vertically, to allow for proper upward heat' dissipation and increase the longevity of the component.

Actually, relays could be used in less severe conditions. In this case, the distance between adjacent relays can be reduced or abolished. A correct interpretation of the use' conditions allows the optimization of the available spaces. Contact AMRA for more information.

To increase relay' longevity, we recommend mounting relays intended for “continuous use” (permanent power supply), alternating them with relays intended for less frequent use.

For a safe use, the retaining clip is recommended.

For use on rolling stock, relays have been tested to EN 61373 standard equipped with retaining clip(s).

Operation

Before use: if relay is not used, for example after long storage periods, contact resistance may increase due to a natural and slight oxidation or polluting deposits.

In order to restore the optimal conductivity and for standard contacts (**NOT gold plated**) it is recommended to switch several time a load of at least 110Vdc - 100mA or 24Vdc - 500mA. The contacts will be "cleaned" thanks to the electric arc generated during the current interruption and the mechanical self-cleaning action.

The common contact rubs against the fixed poles (NO and NC contacts) both when opening and when closing, which ensures a self-cleaning action.

An increase in contacts' resistance, in most cases, does not represent a problem. Many factors contribute to the correct use of contact and consequently to the relay' long-term reliability:

- **Load:** the current switching generates an electric arc with cleaning effects. For proper electrical cleaning and performance keeping we recommend:
 - o Standard contacts: Minimum current = 20mA
 - o Gold plated contacts: Minimum current = 10mA
- **Operating frequency:** relays are components that can operate with a wide range of switching frequency. High frequency operation also allows a continuous cleaning effect by "sliding" (mechanical cleaning). In case of low frequency operation (for example few time a day), we advise:
 - o Use of contact with currents twice compared to those indicated.
 - o For currents lower than 10mA, use gold plated contacts and connect 2 contacts in parallel, in order to reduce the equivalent contact resistance.
- **Pollution:** the presence of pollution can cause impurities on contact surface. Electric charges attract organic molecules and impurities that are deposited on the contact surface. Electrical and mechanical cleaning, respectively, burn and remove such impurities. In pollution presence, the minimum recommended currents must be respected. In extreme cases, provide double the cleaning current.

Condensation is possible inside the relay when energized and the outside ambient temperature is cold; this is quite normal and does not affect the operation of the relay. Plastic materials of relay do not possess hygroscopic properties.

Maintenance

No maintenance is required.

In case of normal relay wear (reaching the end of electrical or mechanical life), the relay cannot be restored and must be replaced.

To check the component, relay removal must be carried out with slight lateral movements. An "up and down" movement can cause terminals damage.

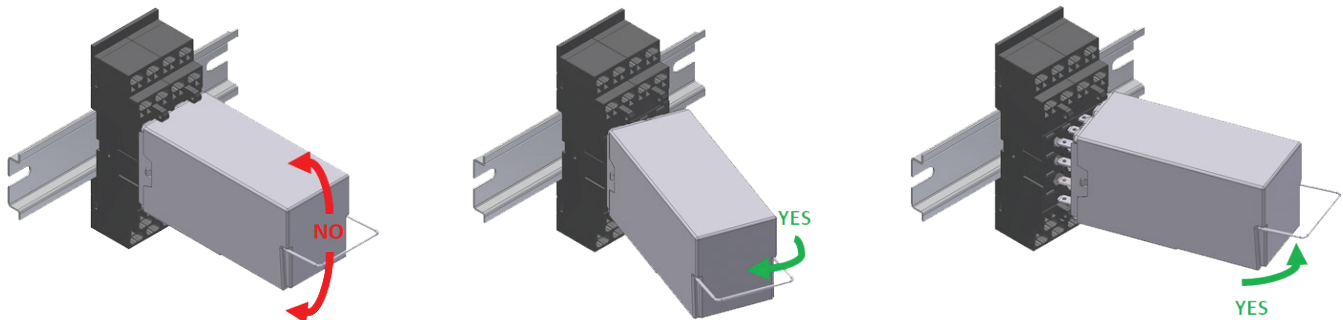

Often the malfunctions are caused by power supply with inverted polarity, by external events or by use with loads exceeding the contact performance.

In case of suspected malfunction, energize relay and observe if mechanical operation of contacts / relay mechanism is performed. Pay attention to the power supply polarity, if relay is equipped with polarized components (example: diode, led).

- In case of expected operation, clean the contacts (see paragraph "OPERATION") and check if the circuit load ranges within the contact performance. If necessary, replace with relays with gold contacts. Note: the electrical continuity of contacts must be checked with adequate current.
- If it does not work, we recommend to use a relay of the same model and configuration.

If an investigation by AMRA is required, pull-out the relay from the socket, don't remove the cap, avoid any other manipulation and contact us. You will be asked for the following data: environmental conditions, power supply, switching frequency, contact load, number of operations performed.

The fault can be described through the "TECHNICAL SUPPORT" section of the website www.amra-chauvin-arnoux.it.

In any case, the relay cannot be repaired by the user.

Storage

Storage conditions of the materials awaiting use must guarantee the environmental conditions (temperature, humidity and pollution) required for the product conservation, in order to avoid deterioration.

The product must be stored in an environment sheltered from atmospheric agents and not polluted, with an ambient temperature between -40 and +70°C with max 75% RH. Humidity can reach peaks of 95%. In any case, there must be no condensation. Before use, please read carefully "OPERATION" section.

Connection: **REAR**
Terminal type: **SPRING CLAMP**
Mounting: **PANEL**

PRIR08x
PRIR16x
PRIR24x
PRIR32x
PRIR48x

3.18

Also suitable for



OVERVIEW

- Cable secured with spring clamp mechanism
- Insertion of lug with no need for tools
- Quick and easy wiring, saving more than 75% of time taken with conventional wiring
- Panel mounting
- Excellent contact pressure on relay terminals
- Sturdy construction, no internal soldering
- Compatible with cable up to 2.5mm², bare (flexible or rigid) and with lug; 2 inputs per terminal
- Provision for fitment of keying pins
- Provision for fitment of retaining clip
- Protection IP20



PRIR08x



PRIR16x

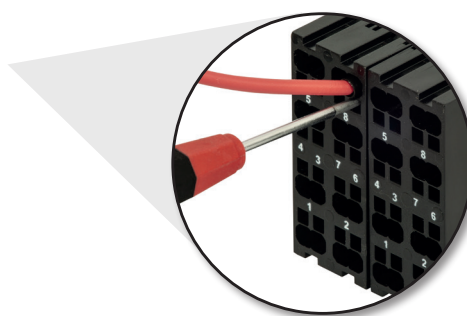

Detail of connections



PRIR24x



PRIR32x



PRIR48x

PRIR08x

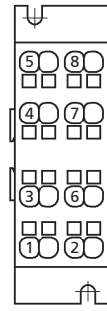
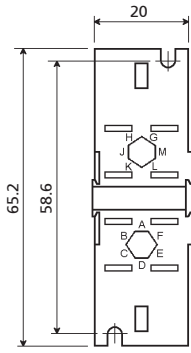

PRIR080
Rear view

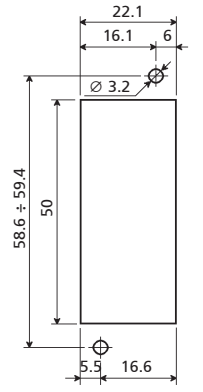

Drilling template

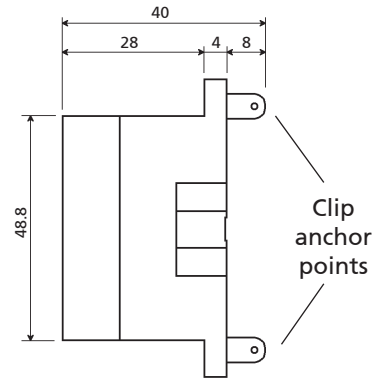

Side view

PRIR16x

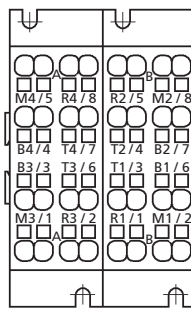
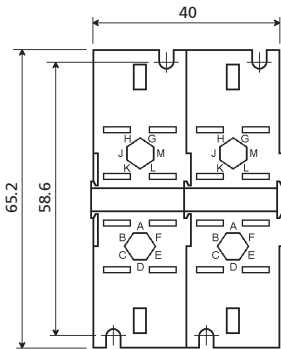

Rear view
PRIR160

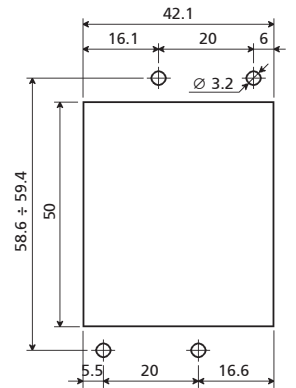

Drilling template

PRIR24x

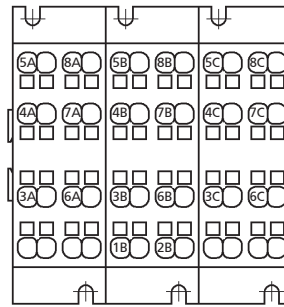
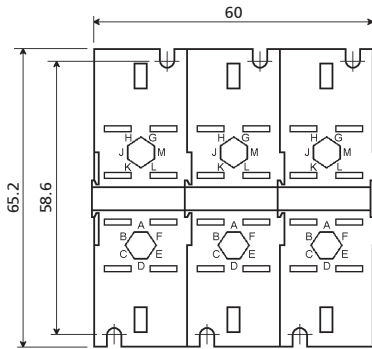

PRIR240
Model with "TRIPOK" numbering
Rear view

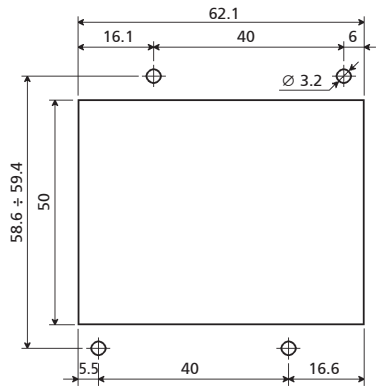

Drilling template

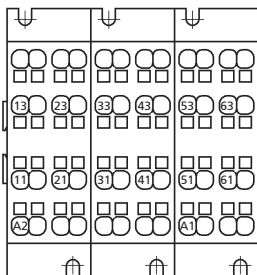

PRIR241
Model with numbering for RVLV16/1

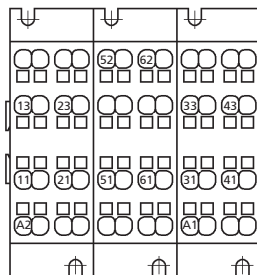

PRIR242
Model with numbering for RVLV16/2

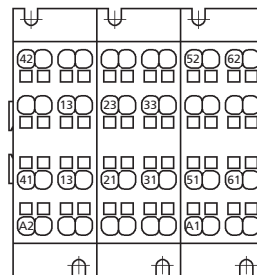

PRIR243
Model with numbering for RVLV16/3

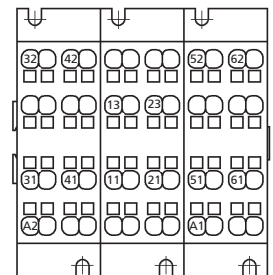

PRIR244
Model with numbering for RVLV16/5

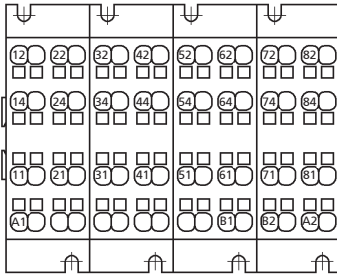
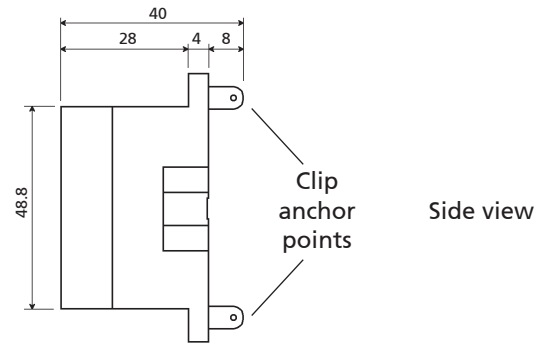
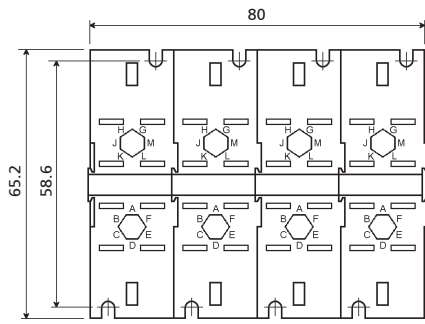

PRIR320 Rear view

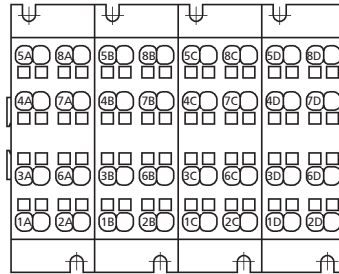

PRIR321 Rear view

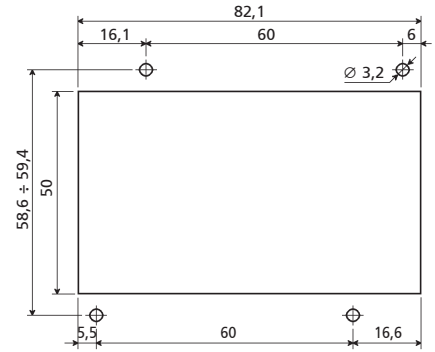

Drilling template

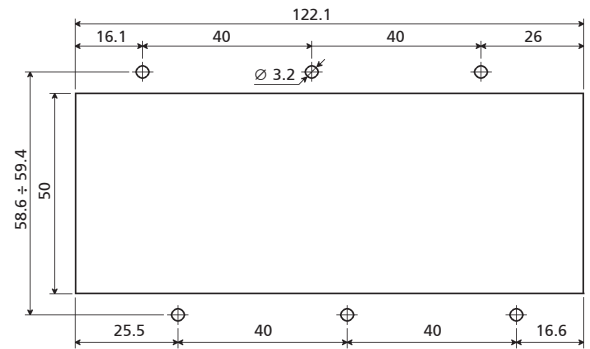
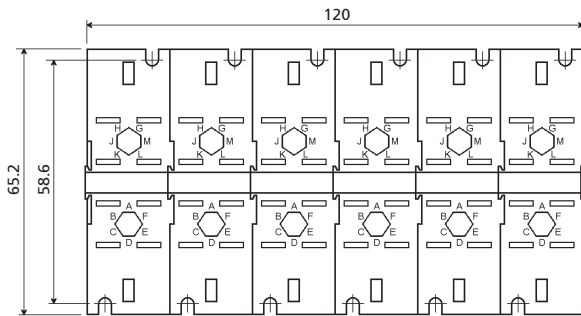

Drilling template

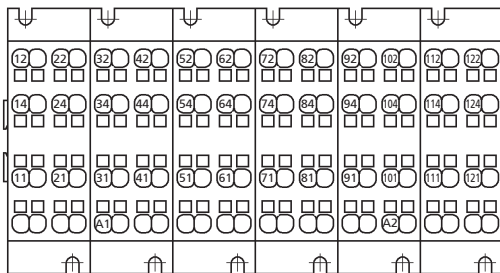

PRIR480 / Model with "ESAPOK" numbering

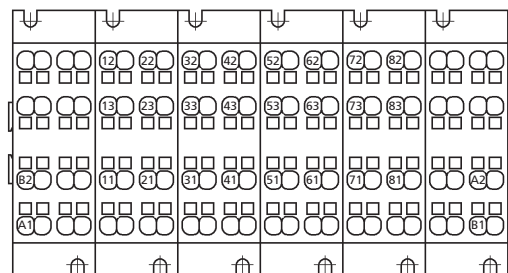

PRIR481 / Model with "BAS8NB" numbering

Specifications

Weight: 35 / 70 / 105 / 140 / 210 g
 Operating temperature: -50°C...+70°C
 Storage temperature: -50°C...+85°C
 Panel mounting:
 • ϕ holes: 3,2mm
Degree of protection: IP20
Insulation voltage:
 - between adjacent terminals: 2.5 kV 50 Hz for 1 min
 - between terminals and external ground: 4 kV 50 Hz for 1 min
Fire resistance: EN60695-2-1, UL94 - V0, EN45545-2, NFPA130
Norme: EN 61810, EN61373

Angle of insertion tooling: 90° ± 5° from insertion surface
Terminal type: spring clamp
Inputs for each relay terminal: 2
Minimum section of cable:
 • cable without lug: 0,5 mm²
 • cable with lug: 0,5 mm²
Maximum section of cable: 2,5 mm²
Wire stripping length, mm: 10 mm ± 0,5 mm
Length of lug: 12 mm
Wiring with rigid cables or lug: pressure grip
Wiring with flexible cables, extraction of cables: using screwdriver type tool with slim shaft and slotted head measuring 2.5mm x 0.4mm, inserted perpendicularly to the socket.

PRODUCT IN SHORT:

PRIR socket series (rear connection) expands the wide range of AMRA sockets and support the **PAIR** series (front connection), already on the market since 2012. Wire connection is made by highly reliable spring clamp terminals.

This technology, already available on the market since many years, has been introduced on AMRA sockets in order to profit of several, economical as well as technical, advantages during wiring operations.

PRIR sockets can be used for both solid and flexible wires from 0,5 to 2,5 mm², both with and without cable lug.

Each electrical connection has a double wire entry; this allows the connection of 2 wires for each relay terminal and to realize, for example, parallel or series connections and distribution of a common ground, **DIRECTLY ON THE PRIR series SOCKET**. It's possible the use of conductors with differing cross-sections, since the spring mechanism is separated for each wire entry.

No tools are required for the direct connection of solid conductors or conductors with lugs. A light pressure is enough to fasten the lead into the socket.

No special tools are required even when inserting flexible leads or unlocking the clamping spring: a common flat-bladed screwdriver is enough for both operations.

Wiring by **PRIR** series sockets assures a quicker and easier cabling, by offering a contact quality which is no more affected by diligence or sensibility of each operator who tightens the screw, therefore determining the tightening torque.

This wiring enables a perfect vision of the whole operation as well as a **SAVING IN SPACE**; the distance between a row of sockets and the next one can be reduced by a few centimeters compared to the traditional sockets with screw terminals, which have conductor entries from the top or from the bottom.

This system presents a considerable **SAVING IN TIME** as well: according to an estimation of our major customers, cabling by means of this technology enables to save 75% of the time for cabling compared to the traditional screw-terminal based systems. When it is possible to avoid conductor crimping operation, the saving in time can be still increased.

The contacts do not need to be checked like the contacts set through a screw and it will not be necessary to tighten the screw after strong vibrations or temperature changes. Therefore their operation is not influenced by shocks or vibrations.

FRANCIA - Headquarter



Chauvin Arnoux

12-16, Rue Sarah Bernhardt - 92600 Asnières-Sur-Seine
Tel.: (0033) 1 44 85 44 85 - Fax: (0033) 1 46 27 73 89
info@chauvin-arnoux.fr - www.chauvin-arnoux.fr

AUSTRIA

CHAUVIN ARNOUX GES.M.B.H.

Gastgebgsasse, 27
A-1230 WIEN
Tel.: (0043) 1 61 61 9 61
Fax: (0043) 1 61 61 9 61 61
vie-office@chauvin-arnoux.at
www.chauvin-arnoux.at

GRAN BRETAGNA

CHAUVIN ARNOUX Ltd

Unit 1 Nelson Ct, Flagship Sq
Shaw Cross Business Park Dewsbury
West Yorkshire - WF12 7TH
Tel.: (0044) 1924 460 494
Fax: (0044) 1924 455 328
info@chauvin-arnoux.co.uk
www.chauvin-arnoux.com

SVEZIA

CA MÄTSYSTEM AB

Sjöflygvägen, 35
SE 18362 TÄBY
Tel.: (0046) 8 50 52 68 00
Fax: (0046) 8 50 52 68 10
info@camatsystem.com
www.camatsystem.com

CINA

SHANGAI PUJIANG

ENERDIS INSTRUMENTS Co. Ltd

Building 23 3rd Floor, 1288 Lane
Zhongchun Road Minhang district
Tel.: (0086) 21 65 21 51 96
Fax: (0086) 21 65 21 61 07
info@chauvin-arnoux.com.cn

MEDIO ORIENTE

CHAUVIN ARNOUX MIDDLE EAST

PO Box 60-154
1241 2020 JAL EL DIB
BEIRUT (LIBANO)
Tel.: (00961) 1 890 425
Fax: (00961) 1 890 424
camie@chauvin-arnoux.com

SVIZZERA

CHAUVIN ARNOUX AG

Moosacherstrasse 15
CH 8804 AU / ZH
Tel.: (0041) 44 727 75 55
Fax: (0041) 44 727 75 56
info@chauvin-arnoux.ch
www.chauvin-arnoux.ch

GERMANIA

CHAUVIN ARNOUX GmbH

Ohmstrasse, 1
77694 KELH / RHEIN
Tel.: (0049) 7851 99 26 0
Fax: (0049) 7851 99 26 60
info@chauvin-arnoux.de
www.chauvin-arnoux.de

SPAGNA

CHAUVIN ARNOUX IBÉRICA S.A.

C/ Roger de Flor N° 293 - 1a Planta
08025 BARCELONA
Tel.: (0034) 902 20 22 26
Fax: (0034) 934 59 14 43
info@chauvin-arnoux.es
www.chauvin-arnoux.es

USA

**CHAUVIN ARNOUX INC
d.b.a. AEMC Instruments**

200 Faraday Drive
Dover - NH 03820
Tel.: (001) 800 945 2362
Fax: (001) 603 742 2346
sales@aemc.com
www.aemc.com